



LIBRARY

INSTALLATION GUIDE AND USER MANUAL

Sol-Ark 5K-IP-N

V1.2

Sep 22, 2023

RESIDENTIAL
NORTH AMERICA





READ THE INSTRUCTIONS COMPLETELY BEFORE OPERATING THE EQUIPMENT



Check the utility voltage before turning ON the unit.



Turn ON and program the unit using only batteries.



The unit will be programmed in 120V Single-Phase at 60Hz by default.

Disregarding these instructions could result in permanent damages to the unit

DISCLAIMER

UNLESS SPECIFICALLY AGREED TO IN WRITING, SOL-ARK:

(A) DOES NOT WARRANT THE ACCURACY, SUFFICIENCY OR SUITABILITY OF ANY TECHNICAL OR OTHER INFORMATION PROVIDED IN ITS MANUALS OR OTHER DOCUMENTATION.

(B) ASSUMES NO RESPONSIBILITY OR LIABILITY FOR ANY LOSS OR DAMAGES, WHETHER DIRECT, INDIRECT, CONSEQUENTIAL, OR INCIDENTAL, ARISING OUT OF THE USE OF SUCH INFORMATION. USE OF SUCH INFORMATION SHALL BE ENTIRELY AT THE USER'S RISK.

Sol-Ark is not responsible for system failure, damage or injury resulting from improper installation of its products.

Information in this manual is subject to change without notice.

This manual is only focused on the inverter labeled as: 5K-1P-N.

Contact

Phone: (USA) +1 (972) 575-8875 ext. (2)

Email: SUPPORT@SOL-ARK.COM

Website: WWW.SOL-ARK.COM

Table of Contents

IMPORTANT SAFETY INSTRUCTIONS	5
1. Sol-Ark: At a First Glance	6
1.1 General Description.....	7
1.2 Specifications.....	8
1.3 Wire Gauge Guide.....	10
2. Installation.....	11
2.1 Mounting the Sol-Ark	11
2.2 Integrating Batteries	13
2.3 Ground Connection.....	14
2.4 PV Panels Connection	14
2.5 Integrating a Generator	15
2.6 Grid Peak-Shaving	15
2.7 Automatic Generator Start.....	16
2.8 Integrating Sensors and Accessories.....	16
2.9 Limit Sensor (CT sensor)	17
2.10 Powering-up and Testing the Sol-Ark	19
2.11 Power Cycle sequence.....	20
2.12 LED Indicators	20
2.13 Main screen (Touchscreen).....	20
3. User Interface.....	22
3.1 Basic Setup.....	22
3.2 Battery Setup	23
3.3 Limiter	25
3.4 Grid Setup	29
3.5 Programming Guide.....	30
4. Installation Tips	31
4.1 Battery Charge Controller	31
4.2 Battery Communication with MODBUS/CANBUS	32
4.3 Grid Compliance Settings	33
5. Parallel Systems	34
5.1 Before Enabling Parallel Operations	34
5.2 Parallel Systems Programming Sequence	35
6. Wi-Fi / Ethernet Connection.....	36
6.1 Ethernet Connection	36
6.2 Wi-Fi (PC or Smart Phone).....	36
7. Wiring Diagrams	41
8. Troubleshooting Guide	49
8.1 Sol-Ark Error Codes.....	51
9. Install Verification	52
9.1 Warranty Checklist.....	52
9.2 Limited Warranty: Sol-Ark 5K-1P-N.....	53
10. GUI Screens	54

IMPORTANT SAFETY INSTRUCTIONS

SYMBOLS THAT APPEAR IN THIS DOCUMENT

 **WARNING:** This symbol indicates information that, if ignored, could cause serious injury, equipment damage, or death.

 **CAUTION:** This symbol indicates information that, if ignored, could result in minor injury or equipment damage.

 **NOTE:** This symbol indicates relevant information that is not related to hazardous situations.

WARNINGS

 Read this entire document before installing or using the Sol-Ark 5K-1P-N inverter. Failure to follow any of the instructions or warnings in this document can result in electrical shock, serious injury, or death. Damage to the inverter is also possible, potentially rendering it inoperable.

 High Life Risk Due to Fire or Electrocution – ONLY qualified persons should install the Sol-Ark inverter.

 The system must have Ground connections and Neutral connections. Ground MUST be bonded to Neutral ONLY ONCE in the circuit.

 Solar PV+/PV- are UNGROUNDED. Note, you may ground PV Racking/Mounts, but doing so directly to the Sol-Ark will likely result in damage in the case of a direct lightning strike to the PV array.

 DO NOT connect the grid to the “LOAD” output terminal.

 DO NOT reverse the polarity of batteries. Damage WILL occur.

 DO NOT exceed 500V_{oc} on any MPPT on the Sol-Ark.

 DO NOT turn off the battery breaker if there is current flowing in or out of the battery in any amount.

 DO NOT use impact drivers to tighten any fasteners on the Sol-Ark.

 MUST use Strain Reliefs ON ALL wires entering/exiting the Sol-Ark user area.

 MUST use conduit (or double insulated wire) for AC wires entering/exiting Sol-Ark user area.

 ALL terminals/breakers, including battery, MPPT, and AC Terminal Block inputs, should only have one conductor connected to them.

1. Sol-Ark: At a First Glance

INSPECT SHIPMENT

The box should include all items shown in the component guide. If there is damage or missing parts, immediately call the phone number (USA) +1 (972) 575-8875 Ext. 2.

COMPONENT GUIDE

The Sol-Ark 5K-1P-N system includes the following components:

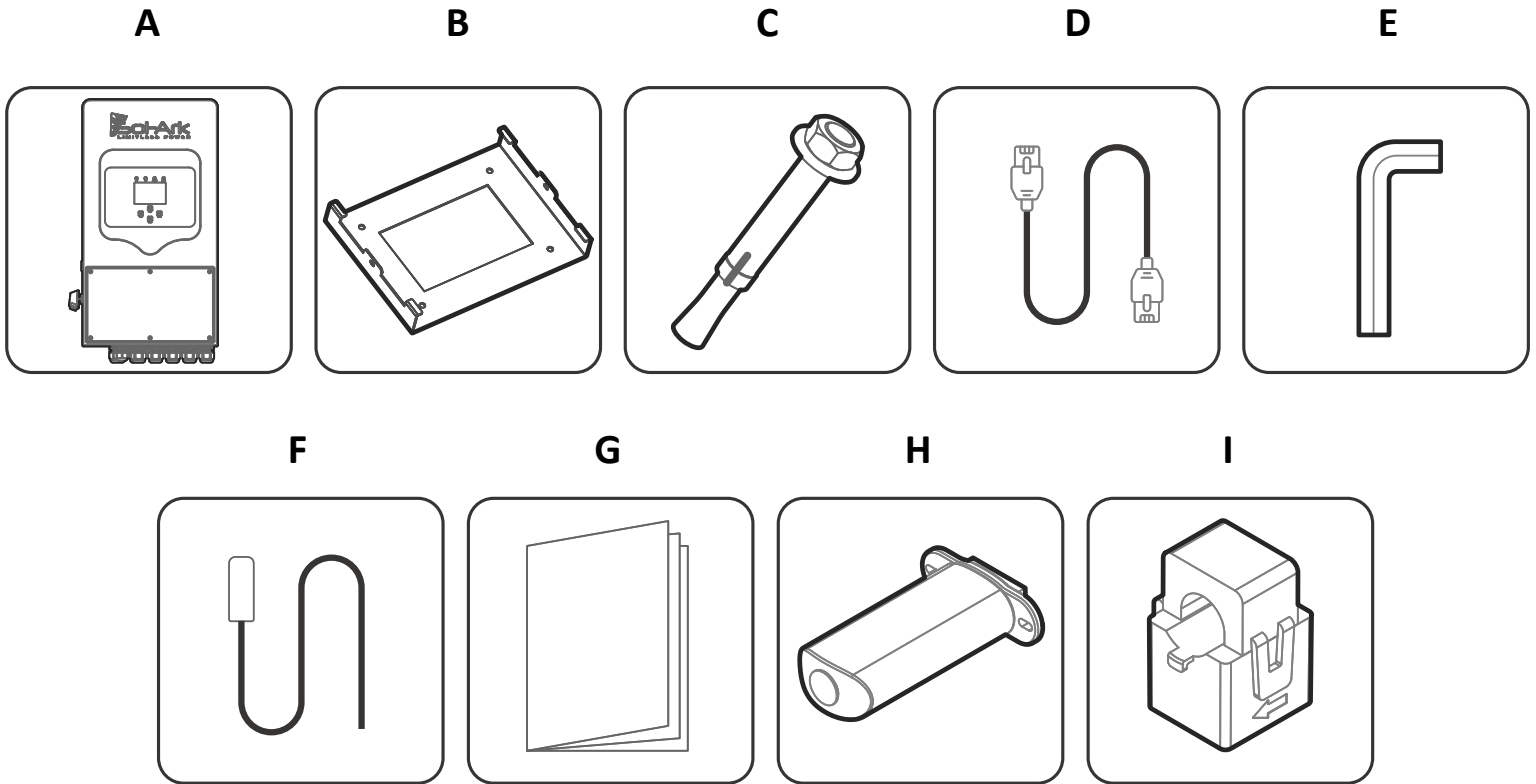

Component	Description	Quantity
A	Sol-Ark 5K-1P-N inverter	1
B	French cleat	1
C	Expansion plugs for concrete M8x80mm	4
D	CAT 5E communication cable	1
E	Allen key (2.4 mm)	1
F	Temperature sensor	1
G	User manual	1
H	Wi-Fi / Ethernet antenna (dongle)	1
I	Current transformer (CT sensors)	1

1.1 General Description

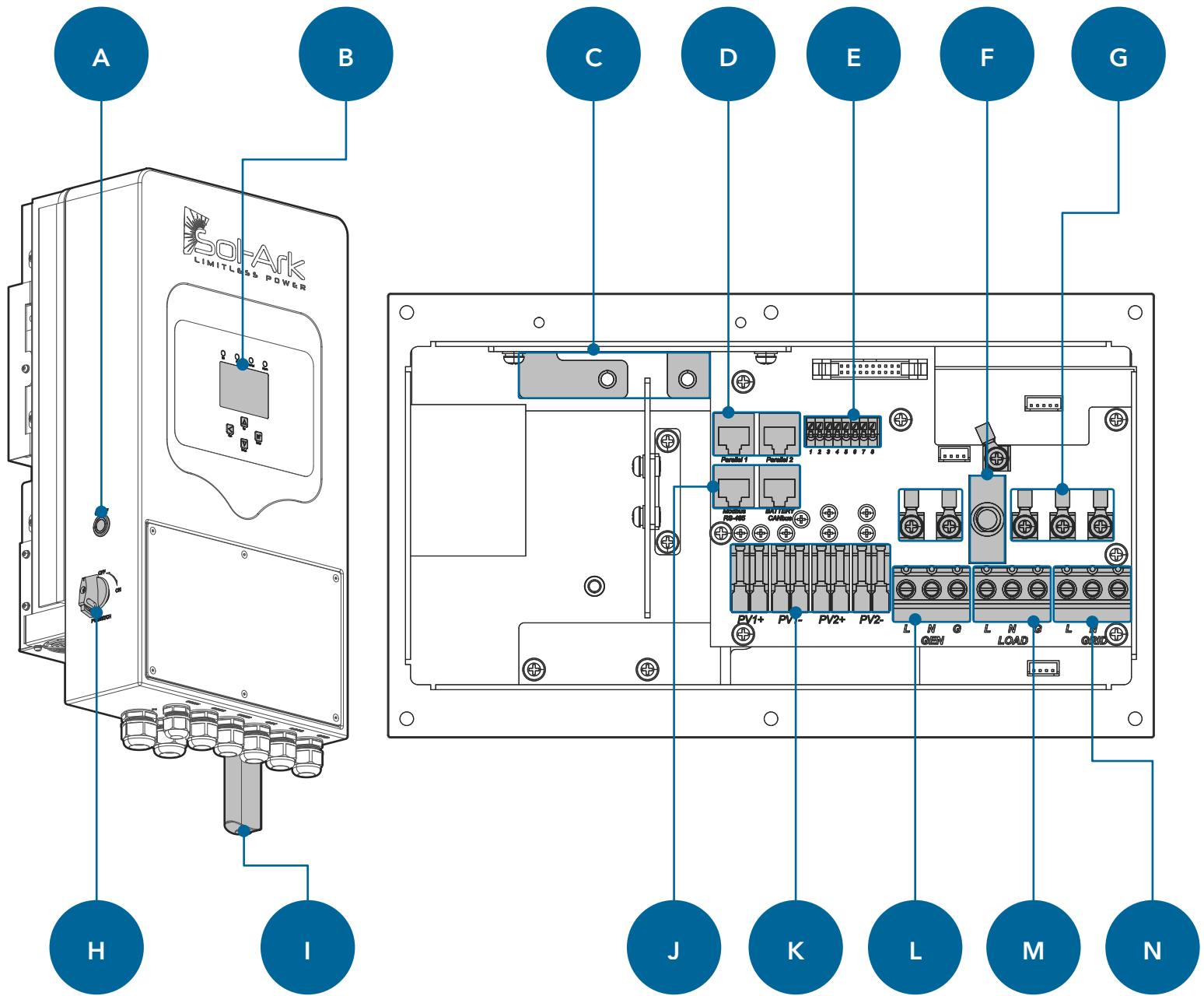

Component	Name	Component	Name
A	ON / OFF Button	H	PV DC disconnect
B	LCD touch screen	I	Wi-Fi / Ethernet dongle
C	Battery terminals	J	BMS RJ45 ports (RS485 / CAN)
D	Parallel RJ45 ports	K	MPPT inputs
E	Input pinouts for sensors and accessories	L	(33A) GEN terminal
F	(50A) LOAD breaker	M	(50A) LOAD terminal
G	Internal AC conductors	N	(50A) GRID terminal

1.2 Specifications

Temperature derating

Optimum: -25°C to 60°C
 Derating: >45°C
 DC: Shutdown @100°C
 AC: Shutdown @82°C

SOL-ARK 5K-1P-N TORQUE VALUES APPLICATION NOTE

Terminal	Torque [in-lb]	Torque [Nm]
"GEN"	17 in-lb	2 Nm
"LOAD"	17 in-lb	2 Nm
"GRID"	17 in-lb	2 Nm
Cover Screws	26.5 in-lb	3 Nm
Battery Connection	40 in-lb	4.5 Nm

Do not use impact drivers to tighten any fasteners on the Sol-Ark



Datasheet

UL: 5K-120V/8K-230V-1P

Input Data (PV)

Max. Allowed PV Power (STC)	10,400W
Nominal Voltage Range	150 - 425V
Startup Voltage	125V
Max. Input Voltage	500V
Input Current per MPPT	Max. 26A (self-limiting 20A)
No. of MPP Trackers	2
No. of PV Strings per MPPT	2

Output Data (AC)

	5K	8K
Nominal AC Voltage	120V Single Phase	240V Single Phase
Real Power, max continuous	4,800W	8,000W
Max. Output Current	40A	33.3A
Peak Apparent Power (5s, off-grid)	7,200VA	12,000VA
Additional AC Output Voltages (single phase)	127V - 220V - 230V	
Grid Frequency	50 / 60Hz	
Max. Grid Passthrough Current	50A	
Power Factor Output Range	+/- 0.8 adjustable	
Backup Transfer Time	5ms	
Max Efficiency	97.6%	
Sell Back Power Modes	Limited to Household / Fully Grid-Tied	
Design (DC to AC)	Transformerless DC	
Stackable	Up to 8 in parallel	

Battery Input Data (DC)

Battery Technologies	Lithium / Lead Acid
Nominal DC Voltage	48V
Operating Voltage Range	40 - 60V
Capacity	50 – 9900Ah
Max. Battery Charge / Discharge Current	120A
Charging Controller	3-Stage with Equalization
Grid to Battery Charging Efficiency	96.0%
External Temperature Sensor	Included
Current Shunt for Accurate % SOC	Integrated
Automatic Generator Start	Integrated
Communication to Lithium	CANBus & RS485

General Data

Dimensions (H x W x D)	600 x 330 x 237 mm / 23.6 x 13 x 9.3 in
Weight	24 kg / 53 lb.
Enclosure	IP65 / NEMA 3R
Ambient Temperature	-40~60°C, > 45°C Derating
Noise	< 30 dB
Idle consumption - No Load	60W
Installation Type	Wall-Mounted
Wi-Fi & LAN Communication	Included
Standard Warranty	10 Years

Protection and Certifications

PV Input Lightning Protection	Yes
Sell Back – UL1741-2010/2018, IEEE1547a-2003/2014	Yes
Anti-Islanding Protection	Integrated
PV String Input Reverse Polarity Detection	Integrated
Insulation Resistor Detection	Integrated
Residual Current Monitoring Unit	Integrated
Output Over Current Protection	Integrated
Output Shorted Protection	Integrated
Surge Protection	DC Type II / AC Type II

1.3 Wire Gauge Guide

1. AC INPUTS / OUTPUTS:

- "GRID" Terminal 50A MAX → 50A passthrough, 8 AWG to 6 AWG conductor.
- "LOAD" Terminal 50A MAX → 50A passthrough, 8AWG to 6 AWG conductor.

! It is possible to use 10AWG conductors if using the inverter for grid sell only.

! Wire gauge should be selected in compliance with your local electrical code.

2. **SENSORS:** 24-20 AWG
3. **SENSORS (CT):** 13 ft [4 m] included
4. **BATTERY TEMPERATURE SENSOR:** Included 9.8 ft [3 m] sensor
5. **CABLE RJ45:** Included 6.5 ft [2 m]. Extendable up to 20 ft [6 m]
6. **BATTERY CABLES:** 2/0 AWG THHN / Max Charge and Discharge limited to 120A

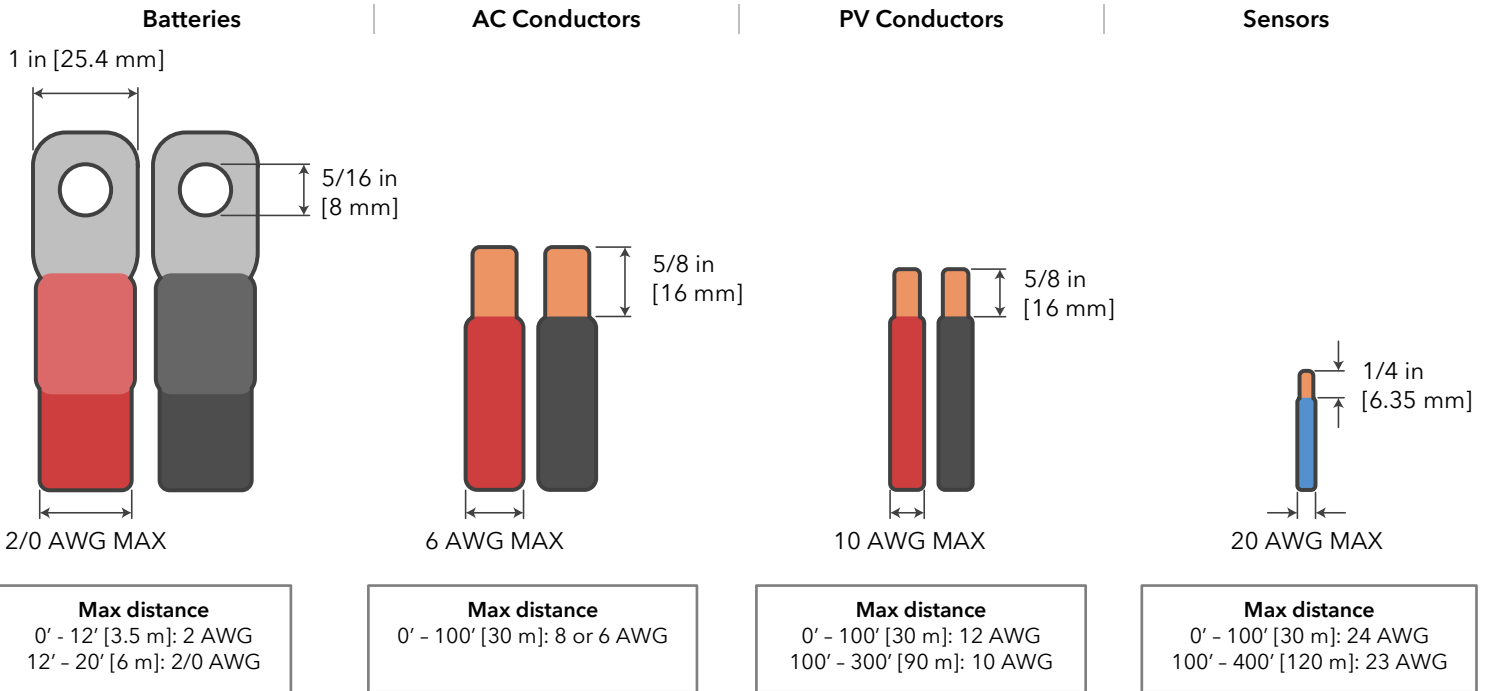

CT Sensor (Included)

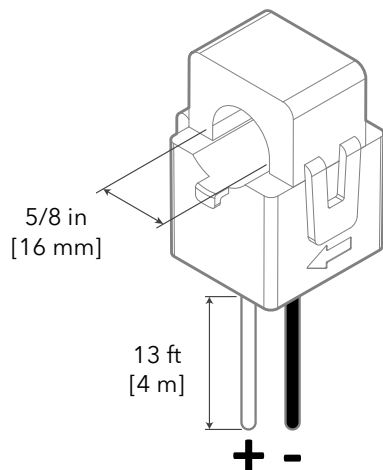

AC Breaker (Single pole)

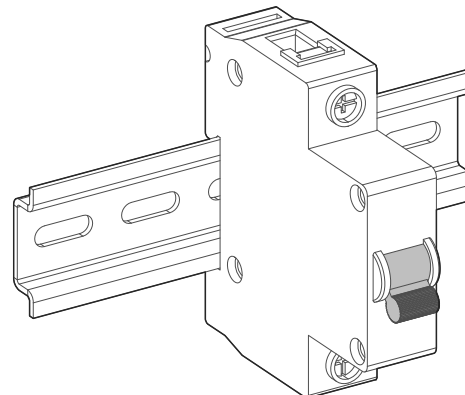

2. Installation

Backup Circuits

- The sub panel powered by the "LOAD" terminal will be considered the essential loads panel.
- You must keep the essential loads panel within the limitations of the unit:
 - Grid Tie → 6 kW = 50A continuous @ 120V (passthrough).
 - Off-Grid → 4.8 kW = 40A @ 120V from batteries or PV.
- Verify that every load circuit power ($P=V*I$) does not surpass the aforementioned limits.

Single System Install

- FOR PARTIAL BACKUP:** Connect the output of your back-feed breaker or line side tap (depending on the point of interconnection) to the "GRID" terminal.
 - A disconnect of 50A must be installed between the interconnection and the Sol-Ark to protect the inverter and conductors.
 - Connect the "LOAD" output to the Essential Loads Panel using 8 AWG to 6 AWG conductors.
- FOR WHOLE-HOME BACKUP:** Connect the incoming grid directly to the "GRID" input terminal.
 - An external disconnect of 50A must be installed between the grid and the Sol-Ark to protect the inverter and conductors.
 - Connect the "LOAD" output to the Main Service Panel using 8 AWG to 6 AWG conductors.

It is possible to connect a generator or an AC coupled source (30A max or 3,600W) such as string or micro inverters to the "GEN" terminal of the inverter. Only one AC source can be connected to the "GEN" terminal at a time.

⚠ An external battery breaker is required. External breakers must be sized according to local AHJ.

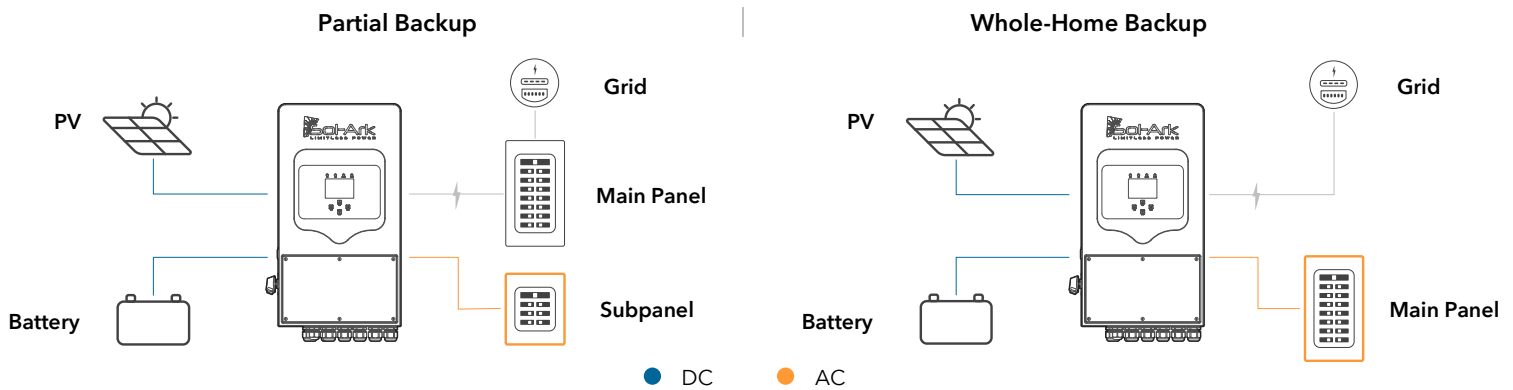

Figure 1: Partial backup or whole-home backup installs

2.1 Mounting the Sol-Ark

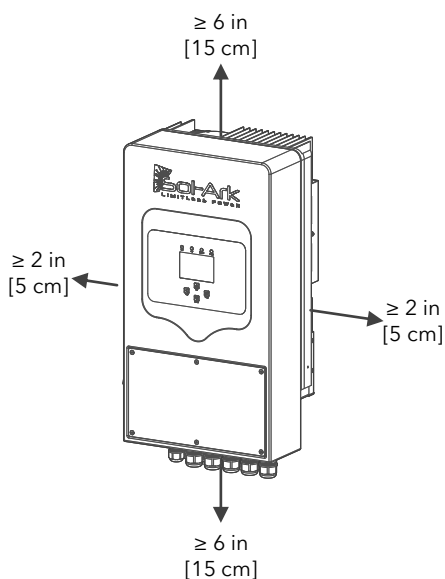

Figure 2: Unit clearances

- System weight: 24 kg / 53 lb.
- Considering the dimensions of the inverter, find a suitable location for the system(s). There must be at least 6 in [15 cm] of vertical clearance for proper heat dissipation.

! Heat transfer is done from bottom to top at a rate of 115.2 W/hr

- The Sol-Ark 5K-1P-N is a NEMA 3R - IP65 enclosure, rated for outdoor installation but can also be installed indoors.
- ⚠ **PROTECT THE LCD SCREEN** from direct exposure to UV light.
- Mount the Sol-Ark and ensure the unit is leveled and properly seated.
- Securely attach to the surface. You may need expansion plugs/anchors for concrete. In case a different anchorage is required, calculate the support needed to properly hold the weight of the equipment.
- Use four (4) screws and washers (choose screw length/diameter based on surface type).

4X $\varnothing \frac{7}{16}$ " \downarrow 3" [80 mm]

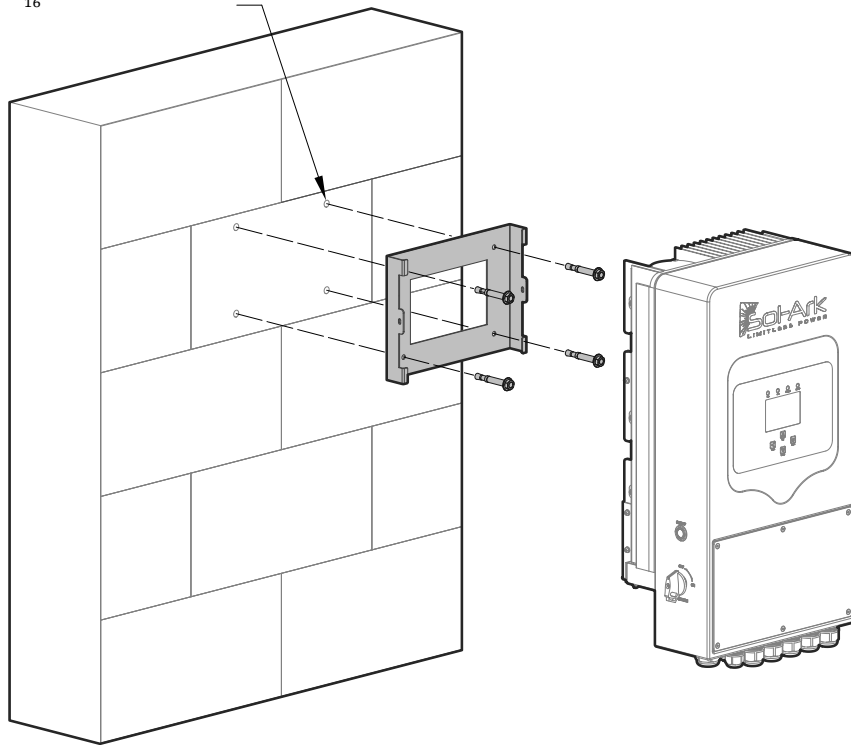

Figure 3: Wall Mount

⚠ Damage to the LCD Screen due to direct sunlight exposure will not be covered by warranty

H. Mount the inverter in the optimal orientation as shown below.

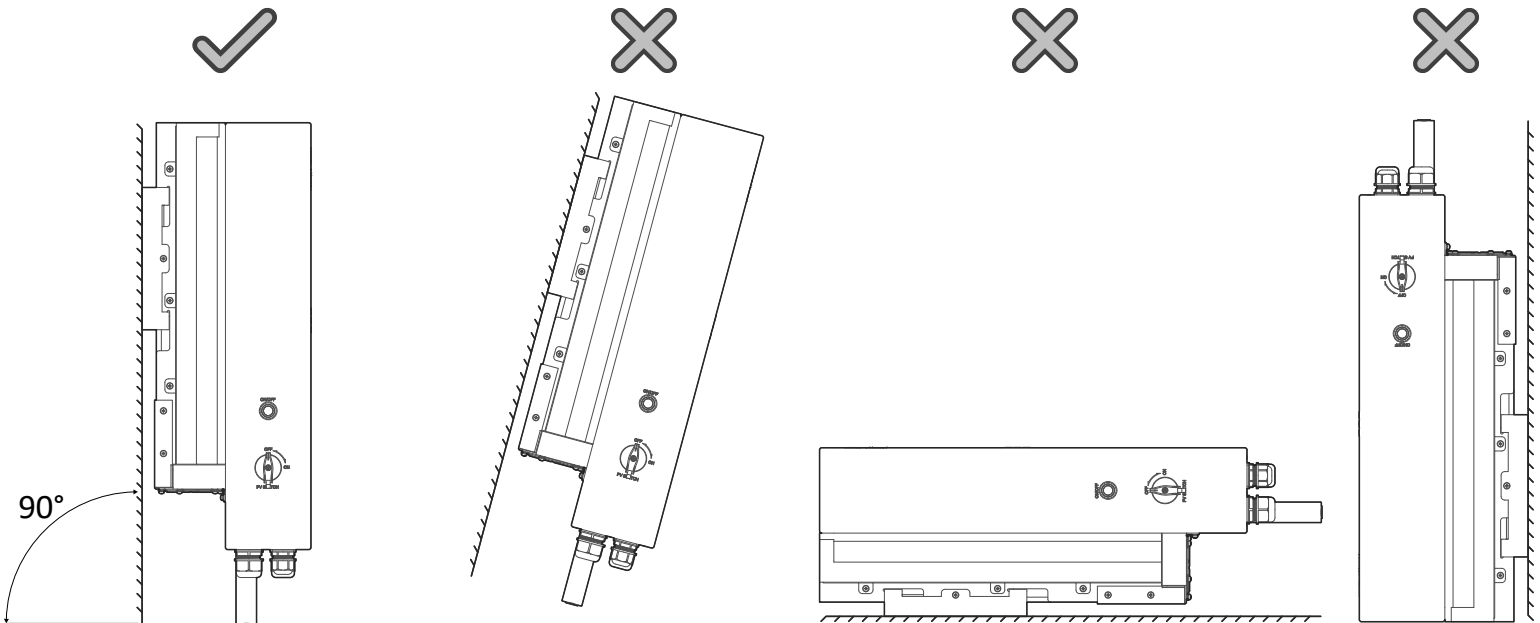

Figure 4: Best practice for mounting orientation

2.2 Integrating Batteries

- ⚠ Sol-Ark 5K-1P-N must be OFF while the batteries are being connected.
- Depending on the battery voltage, wire up the battery bank in the possible configurations shown in figures 5a-5c.
- Internal battery breakers must be OFF when wiring. If your battery bank does not have internal breakers, maintain the necessary safety measures when handling.

⚠ Sol-Ark 5K-1P-N is a **48Vdc nominal system**. **DO NOT** connect the inverter to any other battery configuration. If you use 12V batteries, you **MUST NOT** exceed four (4) batteries in series, as shown in Figure 5b. The inverter can work with any battery chemistry if it remains within the range of **40V to 60V**.

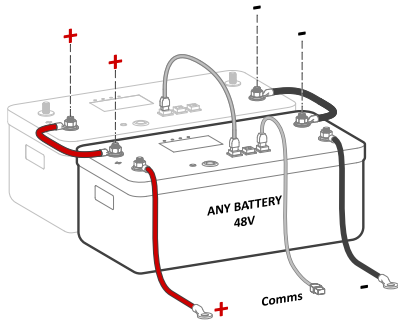

Figure 5a: 48V batteries in parallel connection

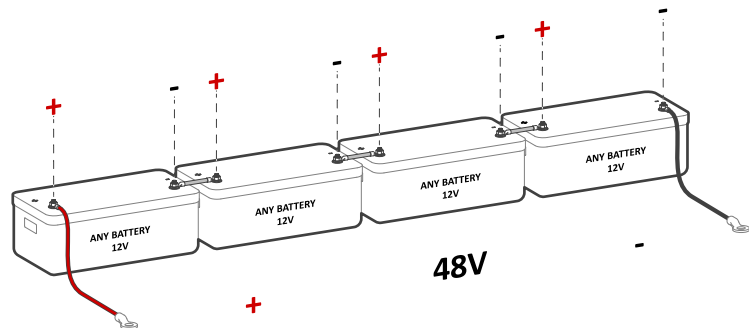

Figure 5b: Four 12V batteries in series connection

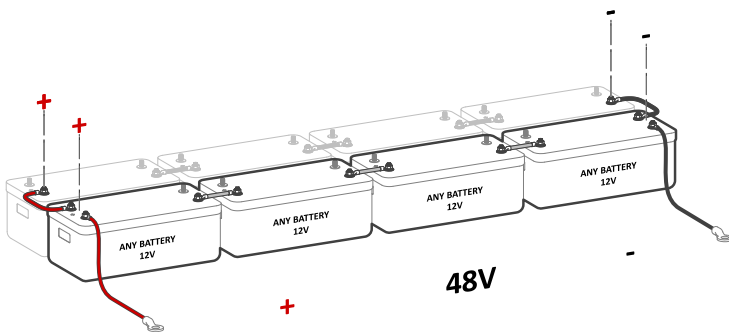
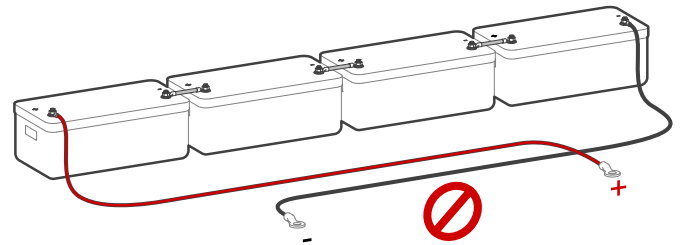

Figure 5c: Series and parallel connections for complete 48V batt bank



⚠ **DO NOT** reverse polarity. The system will be damaged, and warranty will be voided!



IMPORTANT NOTE: Multi-System Install

- ALL** parallel inverters **MUST** connect to a single battery bank. The system will **NOT** operate properly if this instruction is not followed.
- DO NOT** use separate battery banks in parallel systems.

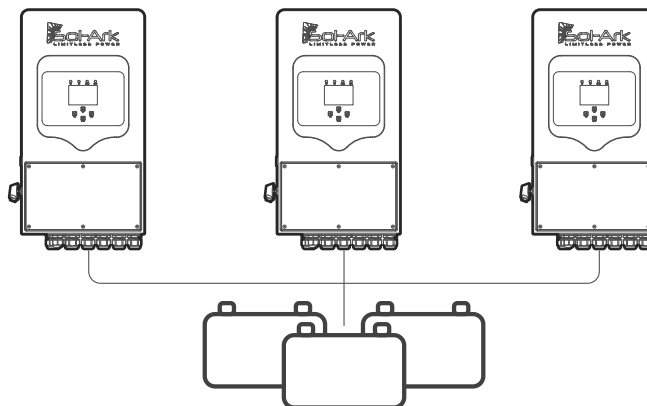

Figure 6: Single battery bank for parallel inverters

2.3 Ground Connection

It is essential to add a grounding connection directly into the frame with the goal of protecting the end user in case of experiencing a failure on the original ground conductor.

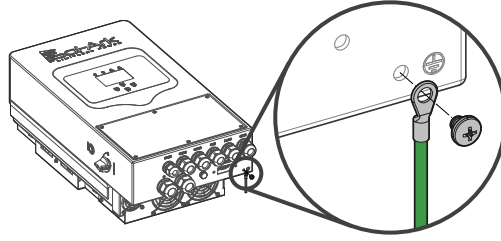

Figure 7: Ground connection

⚠ When the system is installed for an Off-Grid application, the neutral must be connected to ground

2.4 PV Panels Connection

! The inverter has 2 independent MPPTs and each can handle up to 2 PV strings. Each MPPT can operate at a current of 20A (self-limiting) and a MAX Voc of 500V.

- A. Max DC solar input = 10.4 kW ($\pm 5\%$) | Max input power per MPPT = 5.2 kW | Max input voltage per MPPT = 500 Voc | Max input current per MPPT = 20A (self-limiting).
- B. **⚠ There will be damage if Voc > 500V**
- C. **!** Strings in parallel on the same MPPT must have the same designed open-circuit voltage (Voc), otherwise the system will be limited to the lowest string voltage.
 - i. PV1 A/B must have the same Voc.
 - ii. If the solar panels are oriented in different directions and connected in the same MPPT, there will be a loss in PV efficiency.
- D. **!** It is recommended to ground the mounting frame of the PV array to an **external grounding system**.
- E. **⚠** Design for a max input current of 20A per MPPT. The inverter will self-limit beyond 20A. If current exceeds 26A Isc limit, damage will occur.
- F. Connect the solar panel strings using either of the following configurations:

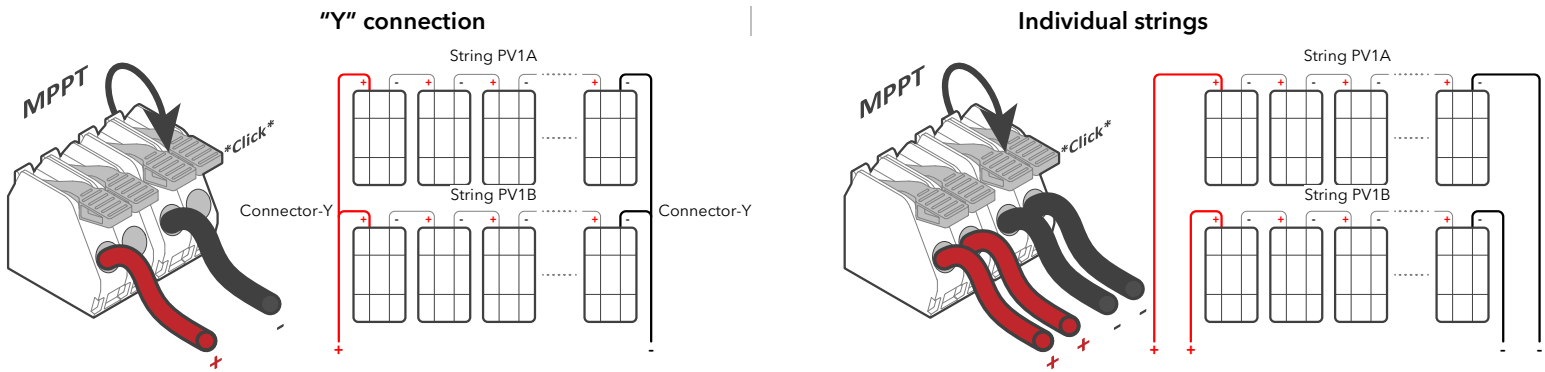

Figure 8: MPPT wiring and PV connections

AC Coupling

The Sol-Ark 5K-1P-N is a system that supports the addition of AC coupled solar panels. The max solar input power can be expanded by coupling micro or string inverters into the "GEN" or "LOAD" terminals. A full AC coupled solar system is not recommended as power control and monitoring is limited. Having DC coupled modules or a combination of DC coupled and AC coupled solar panels is always preferred.

1. AC coupling on "GEN"

- a. Can produce solar power during a grid outage or Off-Grid systems.
- b. Can monitor solar production.

2. AC coupling on "LOAD"

- Can produce solar power during a grid outage or Off-Grid systems.
- CANNOT** monitor solar production.
- ⚠️** "GEN" input **CANNOT** be used.
- !** Backup Transfer Time is extended to 2 seconds.

i In Off-Grid systems, Sol-Ark uses **Frequency Shift** technology to shut down AC coupled solutions when the battery is full. Grid-Tied AC coupled solutions will **always** sell excess solar power back to the grid. "Limited to Load" will **NOT** limit production when AC coupled.

2.5 Integrating a Generator

Generators Smaller than 3.6 kW → On "GEN" Terminal

- Supports single phase 120, 240V generators. **⚠️** External 30A breaker must be installed to protect the inverter and conductors.
- Connect the generator output to the "GEN" input terminal of the Sol-Ark 5K-1P-N.
- A THD (Total Harmonic Distortion) of less than 15% is preferred.

Generators Bigger than 3.6 kW → On "GRID" Terminal

- Supports 120V, 240V generators.
- Off-Grid systems with whole-home generators on ATS (Automatic Transfer Switch) or manual transfer switch connected to the grid input terminal require selecting "**GEN Connect to Grid Input**".

a. **Home Screen** → **⚙️** → "**Dimmer**" → "**Other**" → " **GEN Connect to Grid Input**" → "**OK**"

- An Off-Grid system should **NOT** use "**Grid sell**". CT sensors on generator lines are only needed if using "**Grid Peak Shaving**" to peak-shave the generator.

! **Weekly Gen Exercise:** If a generator has two-wire start compatibility, it will experience weekly generator tests. This test occurs at 8:00AM (local time) every Monday by default. The test takes 20 minutes to complete. The generator will start and stop automatically. The test can be disabled by specifying :00 | 00 min in the "Generator Exercise Cycle Day & Time" option.

Improve the Generator & Sol-Ark Compatibility

Select "**General Standard**" ("Grid Setup" → "Grid Selection" → "General Standard"), then under the "Connect" tab, increase the frequency range to "**Grid Hz High=65Hz**", "**Grid Hz Low=55Hz**" to avoid disconnections from the generator. Additionally, increase the voltage range to "**Grid Volt High=130V**" and "**Grid Volt Low=110V**".

! Sol-Ark will not charge the batteries using the generator unless the "Start V" or "Start %" condition is fulfilled. Only one condition (V or %) will be modifiable depending on which control mode is selected ("Use Batt V Charged" or "Use Batt % Charged")

2.6 Grid Peak-Shaving

- !** To use Peak-Shaving for a generator, it must be connected to the "GRID" terminal.
- Peak-Shaving helps reduce grid consumption during peak demand. Furthermore, it prevents overloads to the generator connected to the "GRID" input.
- Install the CT sensors so that they measure L1 and L2 of the generator / grid input. The arrows on the CTs must point toward the generator / grid.
- Sol-Ark contributes power from the batteries above the programmed "**Power**" threshold.
- This mode will automatically adjust the amperage (A) from "Grid Charge A", to avoid overloads during battery charging.
- !** Grid Peak-Shaving will automatically enable "Time of Use". The "Time of Use" settings must be configured.

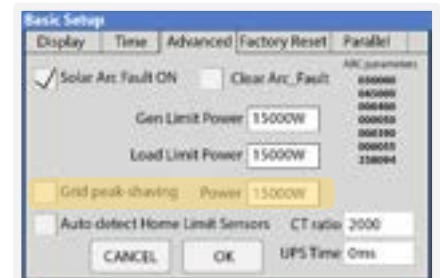





Figure 9: Grid peak-shaving setting

2.7 Automatic Generator Start

1. **"Gen Charge"** is used when the generator is connected to the **"GEN"** input.
 - a. **"Start V" or "Start %"** is the set-point/condition that must be fulfilled to automatically start the generator.
 - b. To charge the battery from the "GEN" source, "Gen Charge" must be selected.
 - c.  Batteries will charge from a generator until the battery bank accepts 5% of its programmed capacity in Amperes (A). This is equivalent to around 95% of the state of charge (SOC).
2. **"Grid Charge"** is used to charge the battery from the **"GRID"** input source (grid or a generator).
 - a. **"Start V" or "Start %"** is the set-point/condition that must be fulfilled to automatically start the generator and begin charging the battery.
 - b. To charge the battery from the "GRID" source, **"Grid Charge"** must be selected.
 - c.  From grid; the batteries will be charged to 100% from utility grid.
 - d.  From generator; the batteries will charge from a generator until the battery bank accepts 5% of its rated capacity in Amperes (A). This is equivalent to around 95% state of charge (SOC).

 If **"Time of Use"** ("TOU") is enabled, **"Gen Charge"** must be checked on desired time intervals. Otherwise, the generator won't automatically start even if the Start V or Start % condition has been met.

Gen Charge / Grid Charge "A"

"A" is how many amps (DC) are supplied to the battery from a generator. Adjusting and limiting the GEN or GRID "A" value will ensure that small generators are not overloaded when charging the battery bank.

If connecting more than one Sol-Ark in parallel, multiply the Gen or Grid "A" value by the **# of Sol-Ark inverters** to get the actual current (A) what will go into the battery bank.

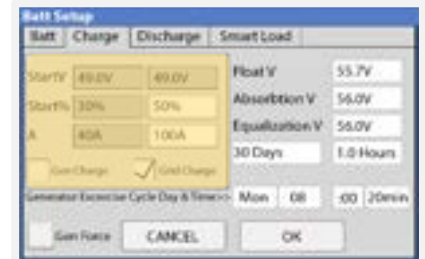

Figure 10: Generator and grid charge settings

2.8 Integrating Sensors and Accessories

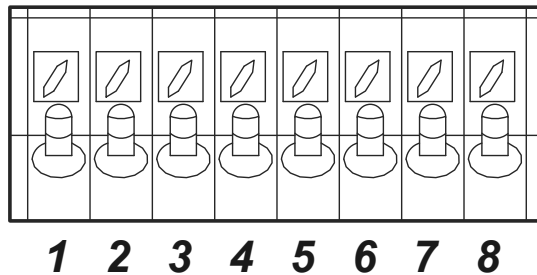



Figure 11: Inverter pinouts for sensors and accessories

- **(1,2) Battery temperature sensor:** Not polarity sensitive. Used for voltage compensation for Lead Acid batteries
- **(+3, -4) CT1:** Current transformer (CT) input
- **(5,6) Gen Start Relay:** Normally open relay for generator two-wire start
- **(7,8):** Not in use

Temperature Sensor

- Place the sensor between two batteries as shown in the next figure.
- Secure with tape and place away from the batteries terminals to prevent overheating.
- This sensor has no polarity. The temperature sensor helps perform voltage charging adjustments and capacity calculations due to changes in temperature.
-  Lithium Batteries **DO NOT** require our external temperature sensor.

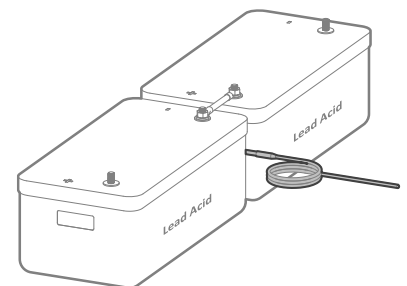

Figure 12: Temperature sensor for Lead-Acid batteries

BMS Port (CAN/RS485)

- This port is used to setup a Lithium Battery in closed-loop communication with the Sol-Ark 5K-1P-N (consult our **"Battery Communications Integration Guide"** on the Sol-Ark website at www.sol-ark.com/battery-partners).
- Must use an RJ45 connector.
- Only use the CAN port for battery BMS communications (the CAN port supports both CANBus protocol and Modbus protocols).

Wi-Fi / Ethernet Antenna (Dongle)

- Remote monitoring and software updates require an internet connection through the Wi-Fi / Ethernet Antenna (Dongle).
- Compatible with Wi-Fi or Ethernet connections.

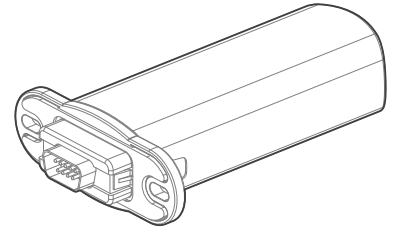

Figure 13: Wi-Fi dongle (antenna)

GEN Start Signal (Two-Wire Start)

- Signal that comes from a normally open relay (5 & 6 sensor pinouts). Relay closes when the generator **"Start"** condition is met.

2.9 Limit Sensor (CT sensor)

The CT sensor (or limit sensor) enable the use and smooth operation of the system work modes known as **"Limited Power to Home"** and **"Grid Peak-Shaving"**. The CT will measure and calculate the demand in the Main Service Panel which the Sol-Ark 5K-1P-N will then use to accurately supply and offset all home loads.

! Off-Grid system do not require CT sensors unless using "Grid Peak-Shaving"

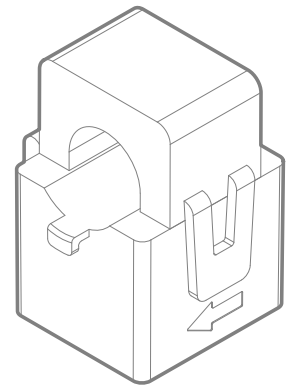

Figure 14: CT Sensor

CT Sensor Installation

- Install sensor on incoming electrical service wires on L1.
- Embossed arrow on the sensor must point toward the grid.
- **"Limited Power to Home"** (Meter Zero) and **"Grid Peak-Shaving"** require CT sensors.
- To ensure proper fit, check incoming wire diameter (grid or generator). If the sensor is too small, bigger CTs can be purchased by calling sales: +1-972-575-8875 ext. 1 or sales@sol-ark.com
- See section 3.3 "Limiter" for more information about the different Sol-Ark work modes.
- See section 7 "Wiring Diagrams" for detailed CT installation.

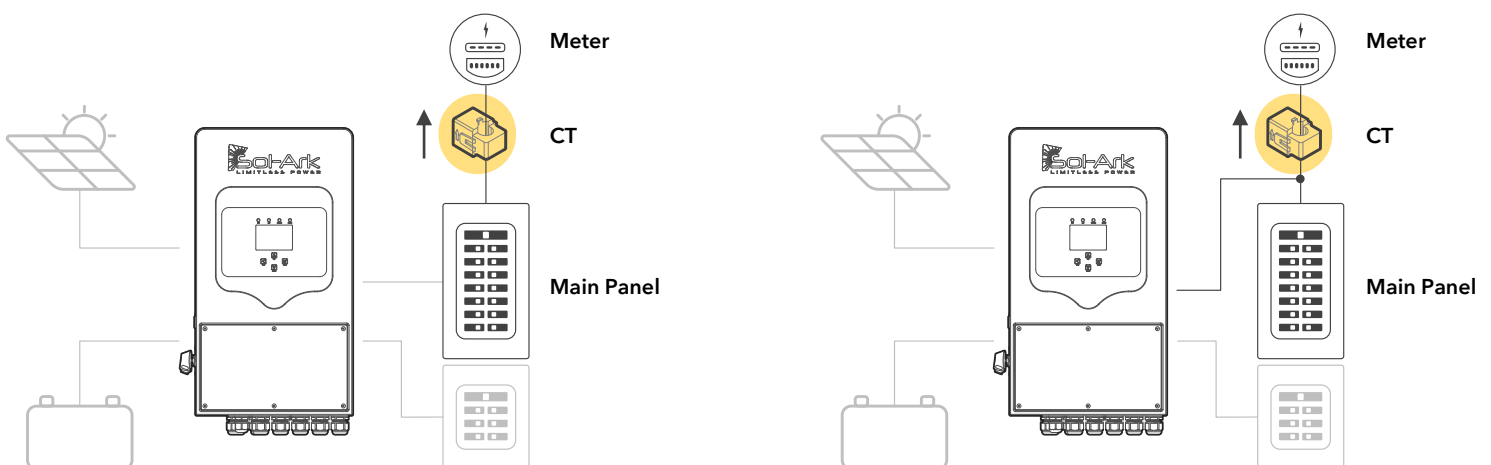

Figure 15: Installation of CTs for a) back-feed breaker and b) line side tap

CT Sensor Size

- Sol-Ark includes one 5/8" CT sensor (100A for 2/0 AWG wire gauge).
- Sol-Ark offers 15/16" CTs (200A for 4/0 AWG wire gauge) and 2" CTs (400A) upon request.
- Default Sol-Ark CT ratio is 2000:1

Unless authorized, **DO NOT** change CT Ratio or warranty will be voided

Wire gauge is the only metric used to determine size of CTs. Contact sales at +1 (972) 575-8875 ex. 1 to purchase bigger CT sensors

Wiring the CT sensor

- Connect CT from phase L1 to pin 3 (white), 4 (black).
- Keep the wires twisted (white-black) throughout the connection.
- If the wires need to be extended, use CAT 6 (shielded) cable to make an extension (see Figure 17).

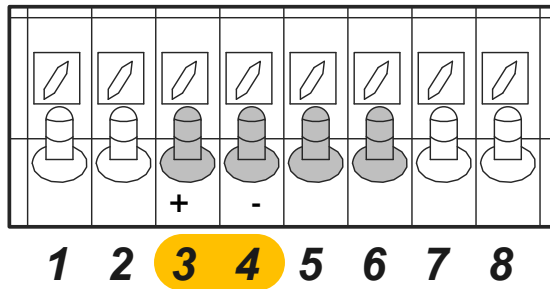

Figure 16: CT input pins on inverter

CT Sensors for Parallel Systems

- Each inverter will include one (1) CT sensor.
- Only one CT sensor must be wired to the designated "MASTER" inverter.
- CT sensors are **essential** for multi-Sol-Ark systems as "Limited Power to Home" mode is highly recommended for multi-system installs.

Automatic CT Limit Sensors Configuration

This function **REQUIRES** batteries and 120/240V grid type to auto detect and auto correct CT orientation. AC coupled inverters need to be **OFF** during the detection test. If this test is done with connected AC-coupled systems, a factory reset of the Sol-Ark must be performed. Install the CT sensor as described in section 2.9 "Limit Sensor". A battery connection and grid power are required before starting the automatic configuration.

→ **Basic Setup** → **Advanced** → **Auto detect Home Limit Sensors** → **OK**

Wait at least 10 to 15 seconds while the inverter performs the test. The inverter will alternate the current distribution in L1, determining the correct orientation of the sensor.

CT sensor troubleshooting

- If you are exclusively using "Limited power to Home" (no Grid Sell), HM values will read close to zero (0). Keep in mind that all sensors have a 3% error.
- To avoid selling power to the utility use "Zero Export Power" equal to or greater than 20W.
- Buying power from the grid will display positive (+) HM values, while selling to the grid displays negative (-) HM values.

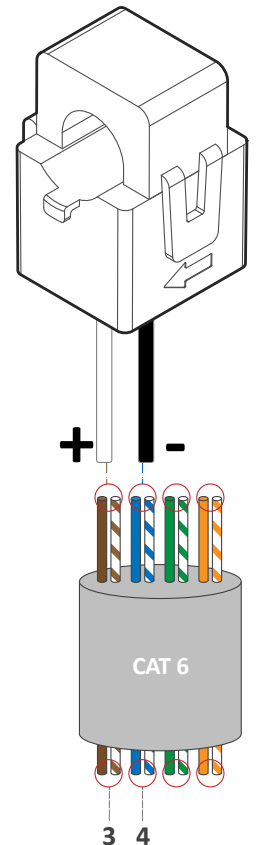

Figure 17: CT wire extensions with shielded CAT 6 cable

2.10 Powering-up and Testing the Sol-Ark

! TURN ON the inverter with at least one power source: 1) Battery, 2) PV or 3) Grid

1. Check the voltage of the battery bank

- ⚠ Voltage of the battery must be between 40Vdc - 60Vdc.
- If applicable, turn **ON** internal switches of the batteries. Measure individual voltages.
- Verify that the voltage of the battery bank at the Sol-Ark terminals is adequate.

2. Check the voltage of each PV input circuit

- ⚠ Input voltage must not exceed 500Vdc.
- Input voltage must be above the startup voltage of 125Vdc.
- ⚠ Do not ground PV+ or PV-.
- ⚠ Verify polarity in each PV string. Backward polarity will measure 0Vdc by the Sol-Ark and will cause long term damage.
- ! PV input will only turn on the LCD screen. Inverter requires **grid power** and/or **batteries** to start inverting.
- PV DC disconnect switch on the side of the inverter will turn the PV ON or OFF.

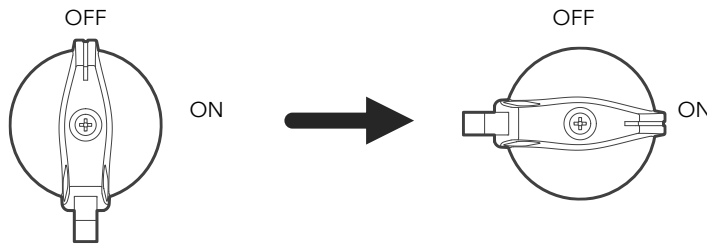

Figure 18: Built-in PV DC disconnect

3. Check GRID input voltage

- Use the top screws above the terminals to measure AC voltages with a multimeter.
- Measure line (L) to neutral (N) voltage on "**GRID**" terminal. Ensure 120Vac.
- Verify that voltage between neutral (N) and ground (G) is 0Vac.
- Verify that voltage between **GRID L** and **LOAD L** is 0Vac.

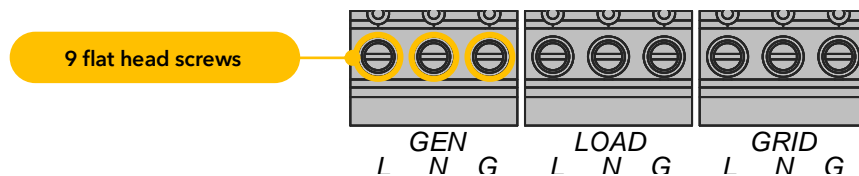

Figure 19: AC Terminals

4. Power ON Sol-Ark

- Turn **ON** the battery breaker. Wait for the "**Normal**" LED indicator to turn on. This may take a few minutes.
- Turn **ON** the PV DC disconnect switch. Wait for "**DC**" LED indicator to turn on.
- Turn **ON** the external "GRID" breaker. Wait for "**AC**" LED indicator to turn on.
- PRESS** the power button of the inverter to the **ON** position.
- Turn **ON** the external "LOAD" and "GEN" breakers.

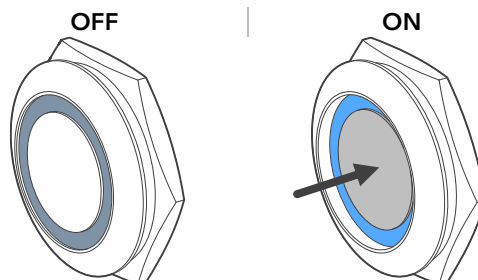

Figure 20: Power Button OFF / ON

2.11 Power Cycle sequence

1. **PRESS** the power button and make sure it is in the **OFF** position.
2. **TURN OFF** all external AC breakers ("GRID", "GEN" and "LOAD").
3. **TURN OFF** the built-in PV DC disconnect switch on the side of the inverter.
4. **TURN OFF** the battery breaker.
5. Wait a moment (~1 min) to ensure the inverter is completely de-energized.
6. Make sure that the Sol-Ark is properly connected to the batteries, solar panels, "GRID", "GEN", and "LOAD".
7. Reverse the steps to turn **ON** the Sol-Ark.

2.12 LED Indicators

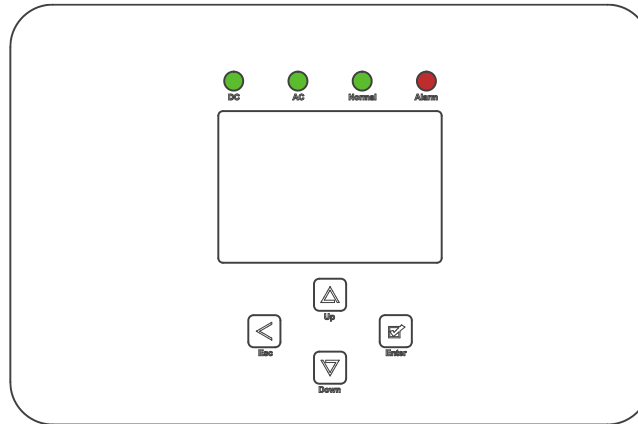

Figure 21: User interface and LED indicators

DC	AC	Normal	Alarm
Green → DC Solar Panels connected and providing voltage. OFF → Minimum MPPT voltage not met, wrong polarity or no PV _{DC} .	Green → Grid is connected and providing voltage. OFF → Grid voltage out of range or Off-Grid system.	Green → Sol-Ark is fully energized* and inverting power. OFF → Not fully energized*, in fault state or in passthrough mode.	Red → Alarm state. Check the alarms menu. Home Screen → ⚙️ → " System Alarms " OFF → No alarms / error codes / setting change notifications

***Fully energizing** the unit constitutes at least: a) DC Solar panels **AND** Grid or b) Just batteries

2.13 Main screen (Touchscreen)

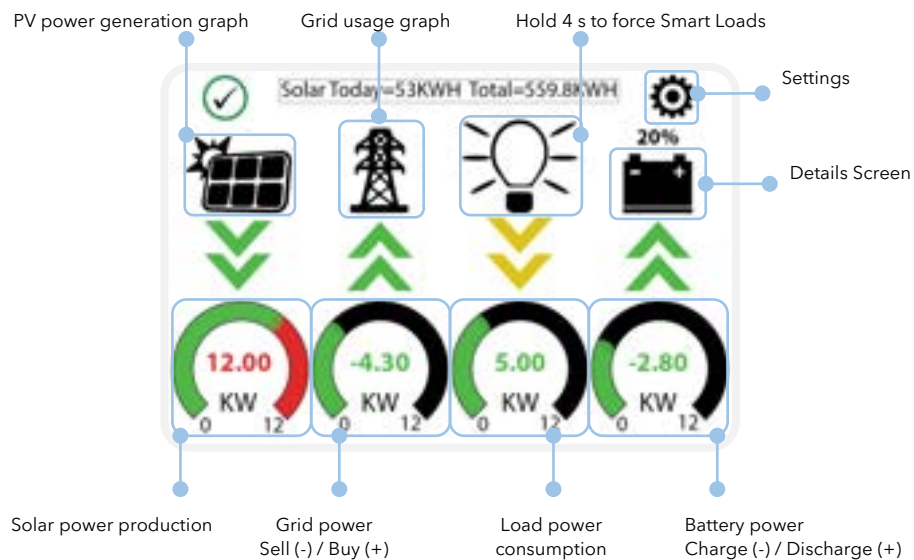

Figure 22: Main Screen

1. Details Screen

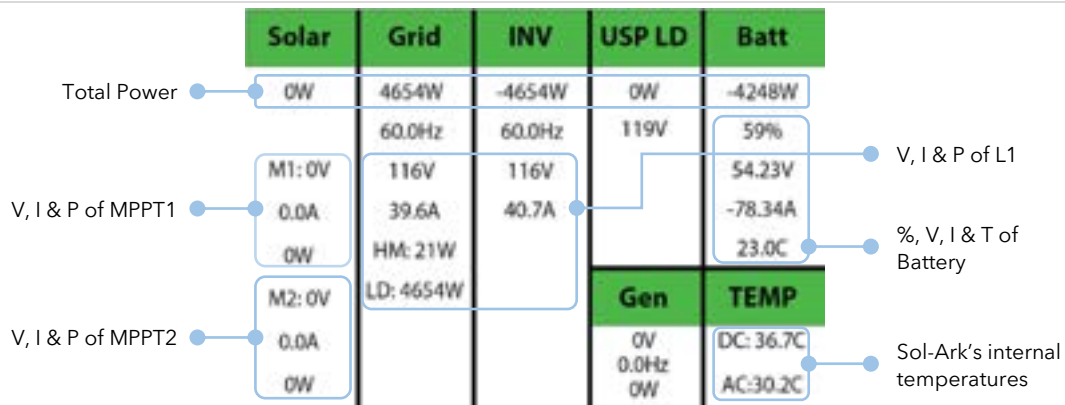

Figure 23: Detail Screen

- ▲ PV voltage from "Solar" column must not exceed 500V.
- Battery temperature will measure 25°C by default if the battery sensor is not connected.
- DC Temp: Internal DC conversion side temperature.
- AC Temp: Internal AC conversion side temperature.
- "Grid" column: power of the grid
 - If selling to the Grid: Watts = negative (-)
 - If buying from the Grid: Watts = positive (+)
 - HM: power detected by the external CT, L1.
 - LD: power detected using internal sensor on "GRID" terminal.

! Opposing "Grid" or "HM" values indicate an incorrect installation of CT. See section 2.9 "Limit Sensor"

2. PV Power Generation Graph

- Display power production over time for the PV array.
- Use up/down buttons (↑, ↓) to navigate between days.
- Month view/ year view/ total production.

3. Grid Usage Graph

- Displays power drawn from grid (+) / sold to the grid (-).
- Values above the line indicate "power bought" from the grid.
- Values below the line indicate "power sold back" to the grid.
- This view can help to determine when the peak power is used from the grid.

4. System Setup Menu

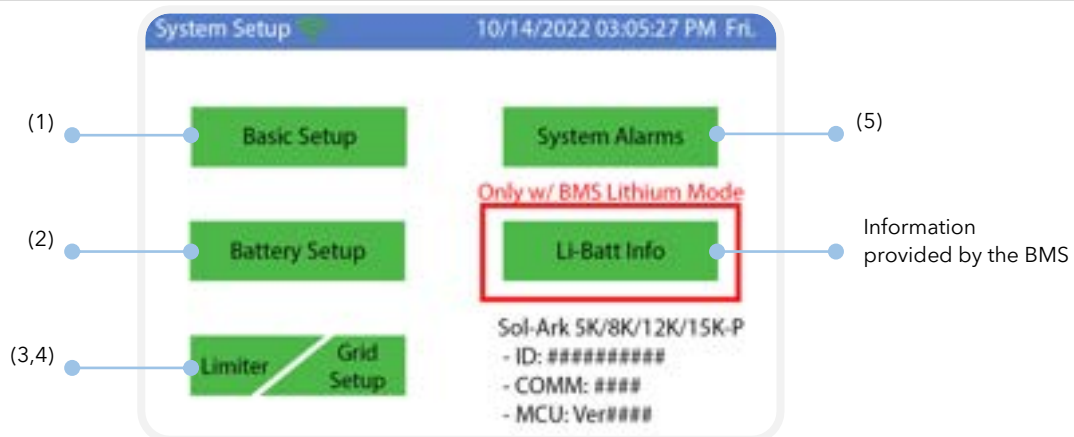

Figure 24: System setup screen

3. User Interface

Main Menu

Solar Today=53KWH Total=559.8KWH

Solar	Grid	INV	USP LD	Batt
0W	4654W	-4654W	0W	-4248W
M1: 0V	60.0Hz	60.0Hz	119V	59%
0.0A	116V	116V		54.23V
0W	39.6A	40.7A		-78.34A
M2: 0V	HM: 21W			23.0C
0.0A	LD: 4654W			
0W				

System Alarms 1/25/2021 03:05:27 PM Mon.

Alarms Code	Occurred
F13 Grid_Mode_changed	2021-01-13 11:22
F13 Grid_Mode_changed	2021-01-13 11:20

System Setup 10/14/2022 03:05:27 PM Fri.

- Basic Setup
- Battery Setup
- System Alarms
- Li-Batt Info (Only w/ BMS Lithium Mode)
- Grid Setup
- Limiter

Sol-Ark 5K/8K/12K/15K-P
 - ID: #####
 - COMM: ####
 - MCU: Ver####

0.00 V 0.00 A 0.0 C 0% 0 Ah
 0.0 V 0.0 V 0A 0A 0x00 0x00

Only w/ BMS Lithium Mode

1. 0.00V 0.00A 0.0C 0.0%	0.0V 0.0A 0.0C
2. 0.00V 0.00A 0.0C 0.0%	0.0V 0.0A 0.0C
3. 0.00V 0.00A 0.0C 0.0%	0.0V 0.0A 0.0C
4. 0.00V 0.00A 0.0C 0.0%	0.0V 0.0A 0.0C
5. 0.00V 0.00A 0.0C 0.0%	0.0V 0.0A 0.0C
6. 0.00V 0.00A 0.0C 0.0%	0.0V 0.0A 0.0C
7. 0.00V 0.00A 0.0C 0.0%	0.0V 0.0A 0.0C
8. 0.00V 0.00A 0.0C 0.0%	0.0V 0.0A 0.0C
9. 0.00V 0.00A 0.0C 0.0%	0.0V 0.0A 0.0C
10. 0.00V 0.00A 0.0C 0.0%	0.0V 0.0A 0.0C
11. 0.00V 0.00A 0.0C 0.0%	0.0V 0.0A 0.0C
12. 0.00V 0.00A 0.0C 0.0%	0.0V 0.0A 0.0C
13. 0.00V 0.00A 0.0C 0.0%	0.0V 0.0A 0.0C

3.1 Basic Setup

Basic Setup Display Time Advanced Factory Reset Parallel

Brightness: [Slider] Beep

Auto Dim 6005 [Slider]

CANCEL OK

Basic Setup Display Time Advanced Factory Reset Parallel

AM/PM Year: 2021 Month: 10 Day: 26

Time Sync Hour: 03 Minute: 04 Second: 15

Seasons Season 1: 1 - 1 Season 2: 4 - 1 Season 3: 8 - 1

Modbus SN: 00

CANCEL OK

Basic Setup Display Time Advanced Factory Reset Parallel

Solar Arc Fault ON Clear Arc_Fault

Gen Limit Power: 15000W

Load Limit Power: 15000W

Grid peak-shaving Power: 15000W

Auto detect Home Limit Sensors CT ratio: 2000

UPS Time: 0ms

CANCEL OK

Basic Setup Display Time Advanced Factory Reset Parallel

Factory Reset System selfcheck

Lock out all changes Test Mode

Lock Grid Charging & Limited

CANCEL OK

Basic Setup Display Time Advanced Factory Reset Parallel

Parallel Master Slave Modbus SN: 00 Phase A Phase B Phase C

Meter > Grid Meter > Load

Meter Select: No Meter

CANCEL OK

Display

Brightness: Brightness adjustment (+, -).

Auto Dim: Must be enabled at all times to validate the warranty of the LCD screen.

Beep: Enable / disable the alarm sound.

Time

Time Sync: Automatically syncs with the internet for daylight saving time changes (Enabling "Time sync" is recommended).

Seasons: Indicates in which seasons TOU will be active.

Advanced

Solar Arc Fault ON: Enables Arc fault detection algorithm on the MPPTs.

Clear Arc Fault: Command to clear an Arc Fault.  It must be executed manually every time the system detects an F63 Arc_Fault alarm. See section 7.1 "Sol-Ark Error Codes" for more detail.

Gen Limit Power: Sets the Sol-Ark limit to keep the power drawn from the "GEN" terminal below the threshold. The inverter will reduce the charge power rate to the batteries if this value is reached.

Load Limit Power: Sets the total AC output power from the batteries to the "LOAD" terminal of the Sol-Ark. The default value is always the maximum output of the inverter production.

Grid-Peak Shaving: Sets the Sol-Ark's threshold to begin contributing power from batteries to keep the power drawn from the grid of generator connected to the "GRID" terminal, below that value.

Auto detect home Limit Sensor: Detects and auto-corrects the polarity of the current transformers (CT sensors).

CT Ratio: Ratio from CT sensor input/output, the default value is 2000:1.  **DO NOT** change this value or you will void the inverter warranty.

UPS Time: Backup transfer time when there is a grid loss. 5ms for lowest transfer time.

Factory reset

Restrictions: Changes to these settings must be previously authorized by Sol-Ark technical support agents.

Parallel

Parallel: Enable whenever you have more than one system connected. "Master" and "Slave".

MODBUS SN: Identification number for each system configured in parallel (1,2,3,4, n).

 See section 5 "Parallel Systems" for more information

3.2 Battery Setup

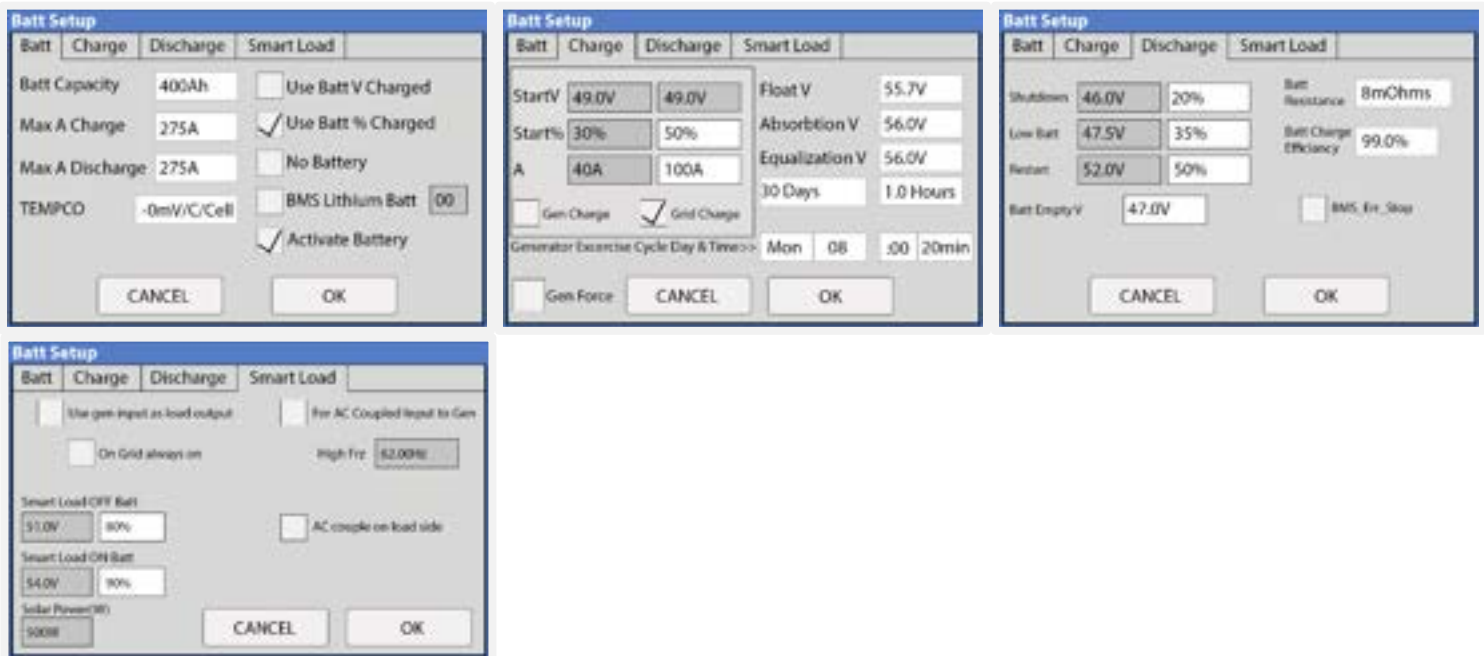



The image shows three screenshots of the 'Batt Setup' interface, each with a different tab selected: Charge, Discharge, and Smart Load.

- Charge Tab:** Shows settings for 'Batt Capacity' (400Ah), 'Max A Charge' (275A), 'Max A Discharge' (275A), and 'TEMPCD' (-0mV/C/Cell). It includes checkboxes for 'Use Batt V Charged', 'Use Batt % Charged', 'No Battery', 'BMS Lithium Batt' (00), and 'Activate Battery'.
- Discharge Tab:** Shows settings for 'StartV' (49.0V), 'Start%' (30%), 'A' (40A), 'Float V' (55.7V), 'Absorption V' (56.0V), 'Equalization V' (56.0V), '30 Days' (1.0 Hours), and 'Generator Excessive Cycle Day & Time' (Mon 08 :00 20min). It includes checkboxes for 'Gen Charge', 'Grid Change', and 'Gen Force'.
- Smart Load Tab:** Shows settings for 'Shutdown' (46.0V), 'Low Batt' (47.5V), 'Restart' (52.0V), 'Batt Empty V' (47.0V), 'Batt Resistance' (8mOhms), 'Batt Charge Efficiency' (99.0%), and 'BMS Err Stop'. It includes checkboxes for 'Use gen input as load output', 'On Grid always on', 'For AC Coupled input to Gen', and 'AC couple on load side'.

Batt

Batt Capacity: Battery charge capacity connected to the system; value expressed in Amp Hour (Ah).

 Batteries in series → Voltage adds up (V).

 Batteries in parallel → Capacity adds up (Ah).

Max A Charge: Sets the Max Charge rate of the batteries from solar panels. 120A max

 Rule of thumb for Lead-Acid batteries: If manufacturer does not specify rated charge amps, use 20% - 30% of battery capacity as Max A Charge.

Max A Discharge: Sets the Max Discharge rate for battery. 120A max.

For Off-Grid systems, the battery bank will discharge 120% of this value for a 10 second surge before the inverter faults to prevent battery damage.

TEMPCO: Temperature coefficient used in conjunction with the battery temperature sensor to adjust optimal voltages for lead-acid batteries.  Lithium batteries do not require a TEMPCO setting (-0 mV/C/Cell).

Use Batt V Charged: Displays battery charge in terms of voltage.

Use Batt % Charged: Displays battery charge in terms of %. The inverter uses algorithms measuring power in and out to estimate a true value for state-of-charge %. It compensates for aging batteries.

No Battery: "No Battery" option **MUST** be selected if there is no battery present. A power cycle sequence is **REQUIRED** when selecting this option. (Refer to section 2.11 for power cycle instructions).

BMS Lithium Batt: Allows closed-loop communication with our tested batteries included in our "Battery Integration Guide". (Refer to www.sol-ark.com/battery-partners)

Activate Battery: This option **MUST** be selected if the system has batteries, especially with **Lithium** batteries.

Charge

Float V: Lower steady voltage at which the battery is maintained after being fully charged.

Absorption V: Constant voltage used to charge the battery.

- Absorption will stop at 98% of the capacity of the battery bank and then drop to the Float setpoint.
- Example: A 400Ah battery will stop charge reaching 392Ah.

Equalization V: Voltage that the system uses to generate a calculated overcharge, utilizing a higher voltage or equal to the absorption to remove the generation of sulfates in batteries. Used to balance internal cells.  Most Lithium batteries do not need to equalize.

Days: The period between equalization cycles.

Hours: The period taken to equalize batteries.

-  If "Hours" is set to 0 hours, the system will not equalize batteries.

Gen Charge: Uses the "GEN" input of the system to charge the battery bank from a generator.

- Start V:** Voltage at which the system will AutoStart a generator to charge the battery.
- Start %:** Percentage S.O.C (state of charge) at which the system will AutoStart a generator to charge the battery.
- A:** Maximum rate of charge of the batteries from the generator (DC amps).

Grid Charge: There are two scenarios in which this option is used:

- Grid connected to "Grid" input:** The inverter will limit the charge rate to the set value in "A" and the battery will charge to 100% SOC.
- Generator connected to "Grid" input:** It will be necessary to select " GEN connect to Grid input". The system will use "Start V", "Start%" and "A" conditions to charge the battery and stop charging at 95% SOC ( Adjustable upper limit if Time of Use is enabled).

Gen Exercise Cycle (Day & Time): Set a weekly generator exercise schedule. (Day of the week/time/duration length).

Gen Force: Forces the relay close for the generator two-wire start.

 *The generator must be in automatic mode if applicable and must have a two-wire start (dry-contact, normally open) connected to the Sol-Ark. To disable the Gen exercise, adjust the time duration to 0 min.*

Discharge

Shutdown: Battery voltage or % at which the inverter will shut down to protect the battery from an over discharge situation (battery symbol on the home screen will turn red).

Low Batt: Low battery voltage or % (battery symbol on the home screen will turn yellow). Stopping point for TOU.

Restart: Battery voltage or % at which AC output will resume conversion DC to AC after reaching "shutdown" voltage.

Batt Resistance: Internal resistance in mOhms of the battery bank. Used in % SOC batt calculations.

Batt Charge Efficiency: Value provided by battery manufacturer. Used in % SOC batt calculations.

Batt Empty V: Sets the empty voltage and associates this voltage to 0% charge. This value determines the lowest % SOC limit.

Smart Load

- This mode uses the "GEN" input as a load output that delivers power when the battery exceeds a user programmable threshold or when the Sol-Ark is connected to the grid.
- When " Use gen input as load output" is enabled, the "GEN" input terminal turns into an output to power high-power loads such as a water heater, irrigation pump, AC unit, pool pump, or any other loads.
- When " On Grid always on" is enabled, the "GEN" terminal will always output power as long as the grid is connected, regardless of battery charge.

Smart Load OFF Batt: Battery voltage or % at which the "GEN" terminal will stop outputting power.

Smart Load ON Batt: Battery voltage or % at which the "GEN" terminal will start outputting power.

Solar Power (W): Amount of PV production needed before "GEN" terminal starts outputting power.

 GEN terminal is limited to 30A at 120V Off-Grid. (Do NOT exceed!)

AC Coupling Settings - (For AC coupled input)



 Sol-Ark 5K-1P-N is a 120Vac system. AC coupled solutions such as micro or string inverters must be 120Vac. Sol-Ark must be programmed for nominal 240V if planning on adding 240Vac AC coupled solutions

- A.  AC coupled PV arrays must have " **Grid Sell**" enabled while the grid is available.
- B. To use the "GEN" or "LOAD" input terminal as an AC-coupled input for micro inverters or grid-tied string inverters, check the appropriate box according to your connection: " **For AC Coupled Input to Gen**" or " **AC couple on load side**".
- C. The meaning of "Smart Load OFF Batt" and "Smart Load ON Batt" change in this mode.



Smart Load OFF Batt: The % SOC at which the AC-coupled inverter(s) are shut down when in off-grid mode.

-  90% recommended.

Smart Load ON Batt: The % SOC at which the AC coupled inverter(s) are turned on when in off-grid mode.

-  80% recommended.

To use the "LOAD" terminal for AC coupling microinverters or grid-tied string inverters:

- Must select "AC couple on load side".
-  The GEN terminal cannot be used (even though the "GEN" terminal is not physically being used for this mode, AC coupling on the "LOAD" terminal prevents the use of the "GEN" terminals for any other purpose).
- Wire as shown in diagram labeled "AC Coupling in LOAD".
-  Backup Transfer Time is extended to 2 seconds.

3.3 Limiter



Limiter

The Sol-Ark 5K-1P-N inverter will simultaneously utilize different available power sources to satisfy load demand in the electrical service panels (essential loads panel / main service panel). The following work modes allow the user to determine how generated power is utilized.

Grid Sell

Grid Sell: The inverter will produce as much power as it has available from PV array according to the programming. The maximum power that can be sold to the grid will be 4,800W or 8,000W depending on grid type selection.

General description:

- This mode allows your inverter to sell back to the grid all the excess power generated from the PV arrays without limitation.
- The inverter will only show loads connected to the "LOAD" terminal.
- The inverter will measure all power in / out of the "GRID" terminal as grid consumption or grid sell back.

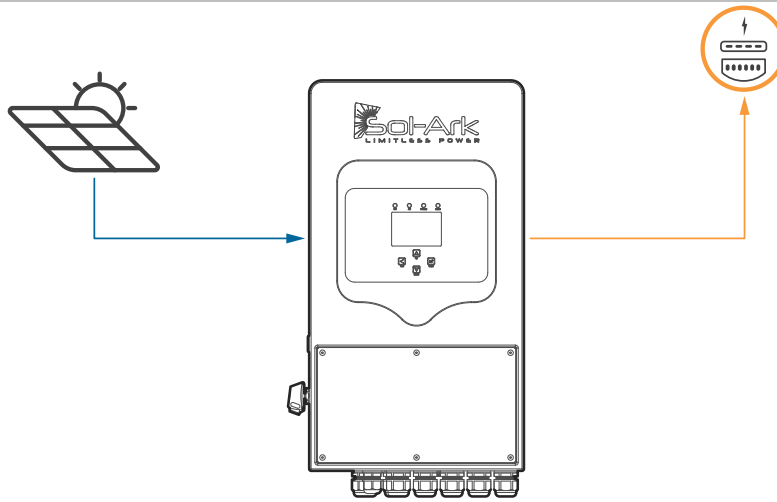

Figure 25: Grid Sell

Limited Power to Home

! This work mode *REQUIRES* batteries

Limited Power to Home (Meter Zero): This mode limits the energy being produced by the inverter to satisfy the home load demand (essential load panel + main service panel). In this mode, the inverter delivers power to the “LOAD” terminal (essential loads panel) + the “GRID” terminal (main service panel). To prevent grid sell back when powering the main service panel, the CT sensors **MUST** be installed. These sensors allow the inverter to calculate the loads in the main service panel wired to the “GRID” terminal. This system work mode is useful for users that don’t have a permit to sell back. See section 2.9 “Limit Sensors” for proper external CT installation.

General description:

- a. Power is delivered to the whole home without selling the excess solar back to the grid (required if no permit to sell back from the utility company).
- b. External CT sensors **required** for proper operation of this system work mode.
- c. Monitored loads will be the addition of the main service panel + essential loads panel.
- d. **Energy Priority:** 1. Solar PV Power | 2. Grid Power | 3. Batteries | 4. Generator

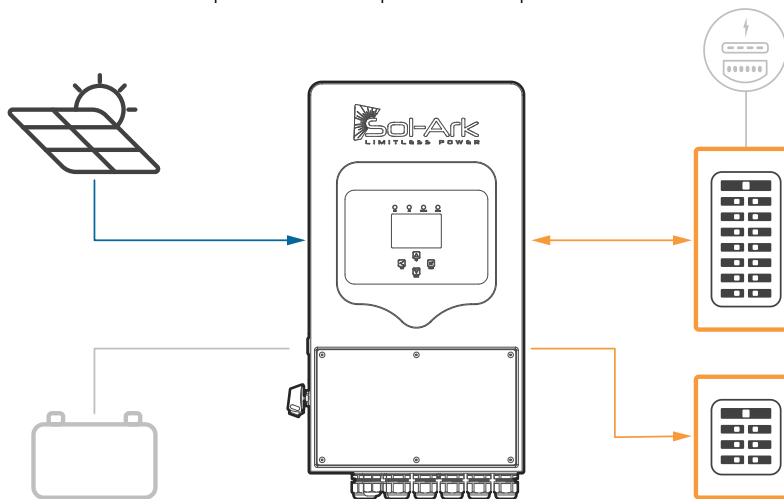

Figure 26: Limited Power to Home

! This work mode is *HIGHLY RECOMMENDED* for parallel systems. “Limited Power to Home” allows optimal power distribution between inverters.

Limited Power to Home + Grid Sell: This mode will NOT limit solar production. In this mode, the inverter delivers power to the “LOAD” terminal (essential loads panel) + unlimited power to the “GRID” terminal (main service panel AND grid). The Sol-Ark will monitor grid sell back and load consumption simultaneously (with +/- 3% error from CT sensors). The CT sensors **MUST** be installed. See section 2.9 “Limit Sensors” for proper external CT placement.

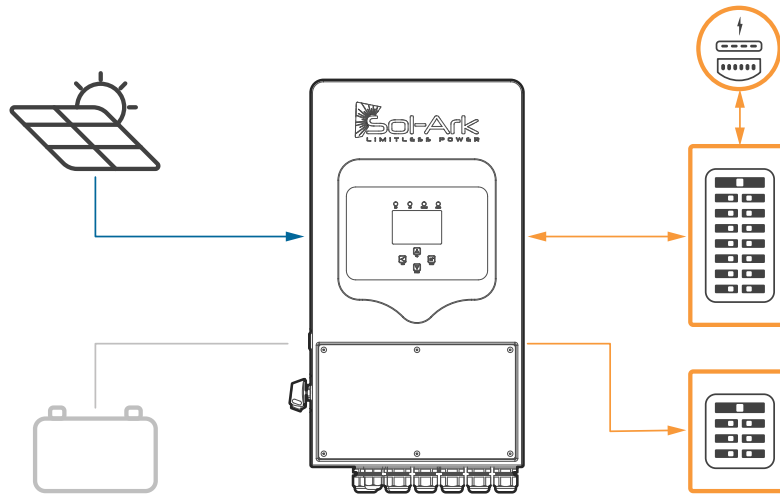

Figure 27: Limited Power to Home + Grid Sell

Limited Power to Load

! This work mode *REQUIERES* batteries

Limited Power to Load: This mode limits the solar production to cover the load demand of the “LOAD” terminal (essential loads panel). In this system work mode, the system disregards the loads in the main service panel and will not deliver power to the “GRID” terminal.

General description:

- The inverter will only cover the loads connected to the “LOAD” terminal.
- It will **NOT** produce more power than the load demand.
- This work mode will **NOT** deliver power to the “GRID” terminal (will NOT sell back).
- The loads reported by the inverter will only be from the critical panel (“LOAD” terminal).
- This system work mode is recommended for off-grid applications.
- Energy Priority:** 1. Solar PV Power | 2. Grid Power | 3. Batteries | 4. Generator

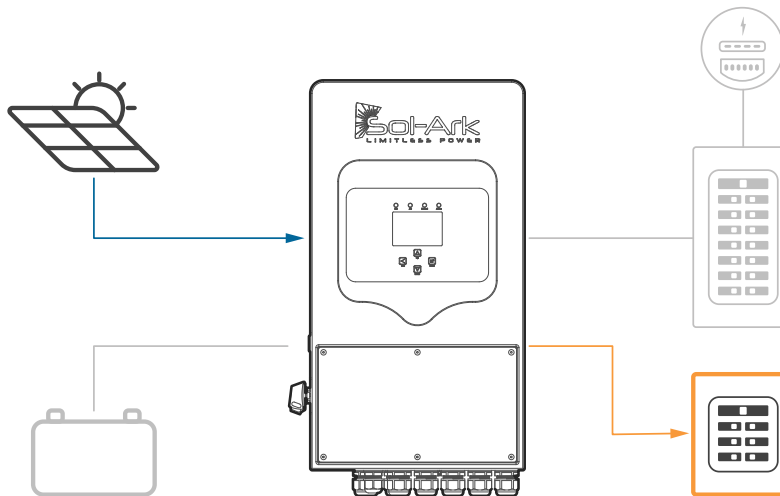

Figure 28: Limited Power to Load

Limited Power to Load + Grid Sell: This mode will NOT limit solar production. The inverter delivers power to the “LOAD” terminal (essential loads panel) + unlimited power to the “GRID” terminal (main service panel AND grid), however it will ONLY track the loads connected to the “LOAD” terminal, but it will sell back excess solar. If there is a main service panel in the “GRID” terminal, the inverter will NOT be able to measure the true value of the total home consumption and grid sell back. This system work mode is recommended for single inverter or for whole home backup installations.

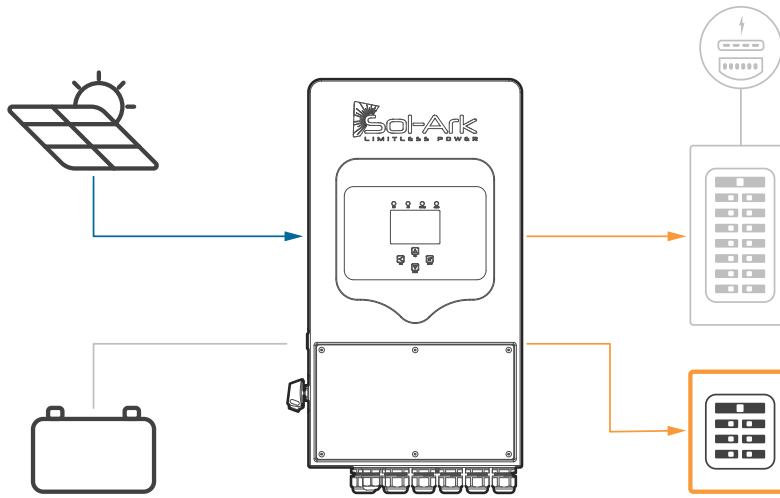

Figure 29: Limited Power to Load + Grid Sell

Time of Use

Time Of Use (TOU): Using this mode, combined with “Limited Power to Home” or “Limited Power to Load”, allows the inverter to discharge the batteries to deliver power to the home and reduce the power consumption from the grid during specific time intervals. The battery discharge will cover the calculated load demand with the threshold discharge power rate set in the “Power(W)” column. You can configure six different discharge rates (Watts) and depth of discharge from the battery (V or %).

General description:

- Uses batteries to reduce the power consumption during user defined periods.
- Energy Priority:** 1. Solar PV Power | 2. Batteries (down to programmed discharge V or %) | 3. Grid Power | 4. Generator.

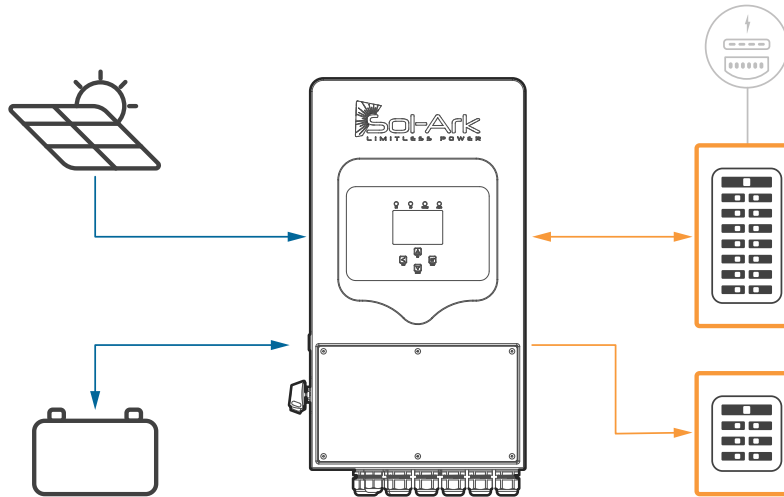

Figure 30: Limited Power to Home + TOU

Time: During these hours the system will provide power from the battery to the home or even the grid if desired. The 6-time intervals **MUST** follow a chronological order. All time intervals are automatically enabled.

Power(W): This is the maximum discharge power the Sol-Ark will draw from the battery during the time intervals.

Batt: Voltage or percentage battery state-of-charge at which the system stops discharging batteries. If **Charge** is checked, the “Batt” V / % setpoint will change its meaning and it will now be the upper limit at which the inverter charges the battery up to with an AC power source (grid or generator).

Charge: Allows the batteries to charge from an external AC power source, such as a generator or grid, during the hours selected, up to the programmed voltage or %. If the external AC power source is a generator, it is also necessary to meet the condition “Start V” or “Start %” located in the Battery Setup to begin charge from a generator. The PV array will always charge the batteries at 100% regardless of the **Charge** box in TOU.

Sell: The **Sell** box in TOU allows batteries to discharge and sell power to the grid at a constant programmable rate for the selected period, determined by “Power(W)”. **Grid Sell** must also be enabled.

Do **NOT** enable “Charge” and “Sell” at the same time

Other

GEN Connect to Grid Input: Enable this option if you have a generator connected to the “GRID” terminal.

Zero Export Power: Minimum power imported from the grid. Helps avoid selling back to the grid by ensuring constant grid consumption. The value can be set between 1 - 100W (recommended 20W).

Batt First: Set the charge priority for the system, the solar PV power will be delivered first to charge the battery (it is recommended to check “Batt First” as it is the most efficient option).

Load First: Set the charge priority for the system, the solar PV power will be delivered to cover the loads consumption first, then the remaining will charge the battery. Only recommended for very specific situations.

3.4 Grid Setup

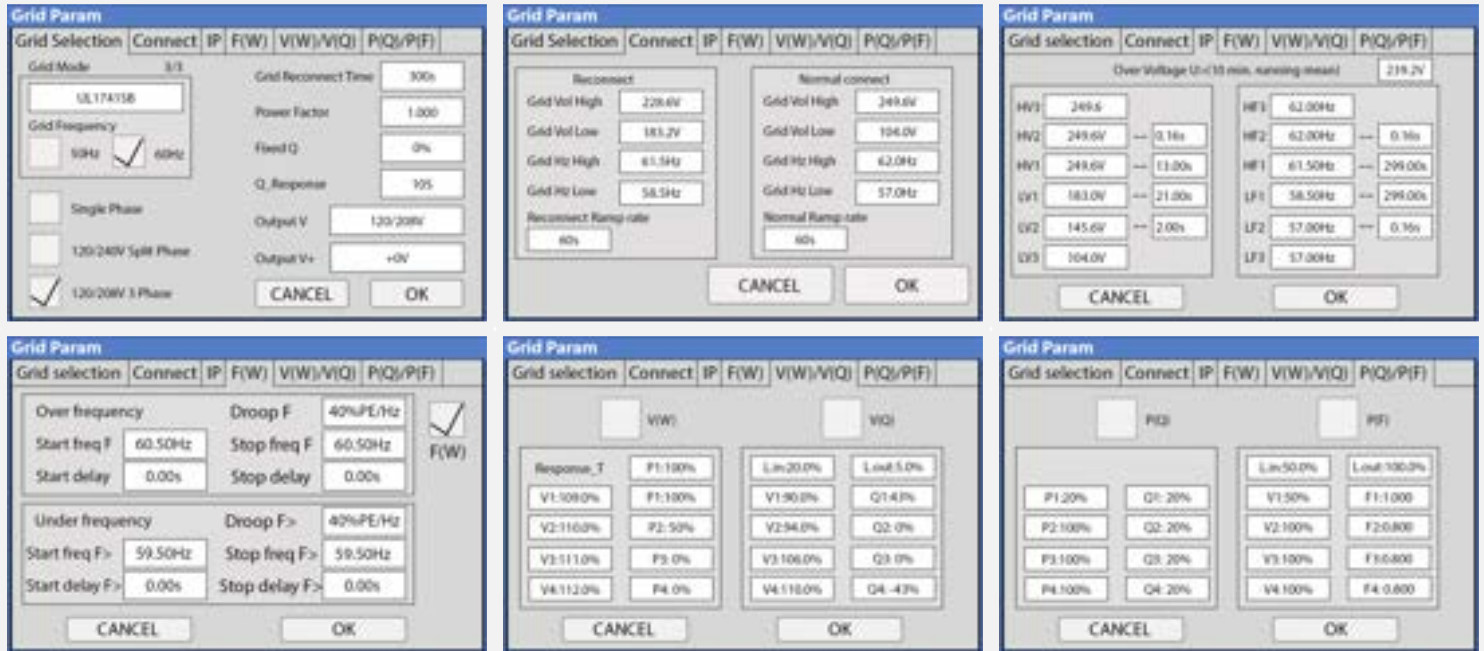

Grid Selection

! The Sol-Ark 5K-1P-N has a wide selection of (single phase) AC voltages it can operate in, including: **120V, 127V, 220V, 230V and 240V.**
Output power will vary depending on grid type selection:

4,800W @ 120V and 127V
8,000W @ 220V, 230, and 240V

See section 1.2 “Specifications” for more detail.

General Standard: Allows more flexible adjustments to the grid parameters, such as widening frequencies and voltages to keep the inverter connected to the grid (useful for off-grid systems with backup generators)

UL 1741 & IEEE1547: Enables sell compliant functionality.

UL1741SB: Enables F(W), voltage, and power factor control to sell back to utility and expands compatibilities. Useful for AC coupled inverters. Expands grid compliances.

Grid Frequency: Frequency of the AC sine wave.

Grid Reconnect Time: The amount of time, in seconds, the inverter will wait before reconnecting to the grid.

Power Factor: The power factor can be adjusted from ± 0.8 to 1.0 (Call technical support if you need to modify this value).

Connect

Normal connect: Protect parameters for the grid. This can only be used with “General Standard”. The voltages shown in this menu correspond to L-N voltage (the maximum difference grid voltage value is +/- 10V).

Reconnect: Protect parameters for the grid after a grid disconnect. This can only be used with “General Standard”. The voltages shown in this menu corresponds to L-N voltage (the maximum difference grid voltage value is +/- 10V).

3.5 Programming Guide

The next diagram shows the most used/common parameters for programming the unit Sol-Ark 5K-1P-N.

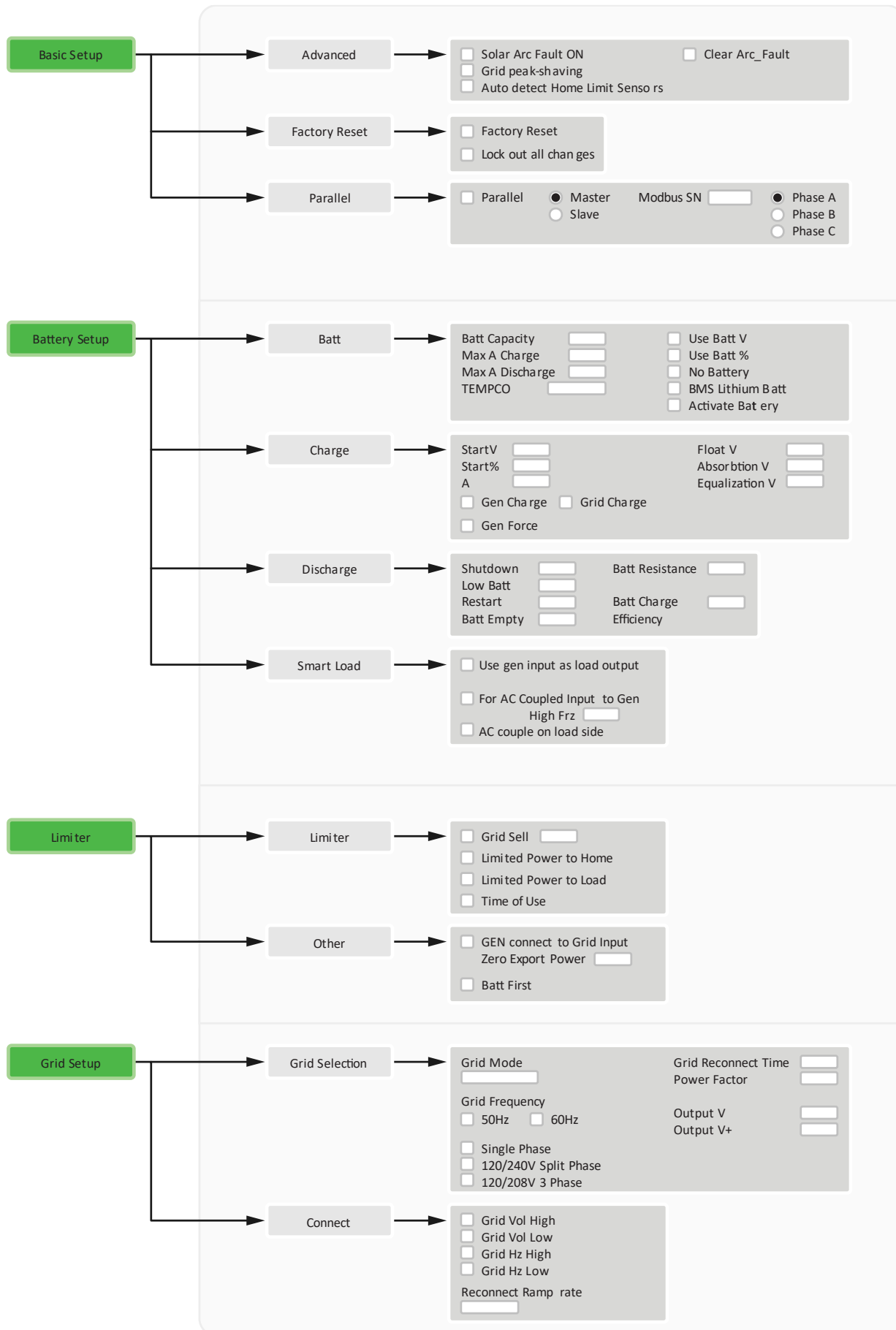

4. Installation Tips

Off-Grid Installation Tips

1. Limit sensor (CT) is not required for completely off-grid installations unless using **"Grid Peak Shaving"** with a generator connected to the **"GRID"** input terminal.
2. It is recommended for generators to be connected to the **"GRID"** terminal so that the **"Smart Load"** function of the **"GEN"** terminal can be used.
3. There is no need for a transfer switch. Connect the **"LOAD"** output of the Sol-Ark to the main panel.
4. Do not use **"Grid Sell"** mode when Off-Grid. **ONLY "Limited Power to Load"** (default).
5. The **"Auto Gen-Start"** function is a dry-contact, normally open 2-wire switch (closes the circuit when needing charging).
 - o Auto Gen-start will be triggered when the battery voltage (V) or percent (%) reaches the level programmed in the Battery Setup menu. Then, the generator will continue to charge the batteries until they are about 95% full. **!** Without Time of Use, this 95% value is not programmable.
 - o An exercise function will turn on the generator once a week on Monday mornings at 8 AM for 20 min by default. This exercise is to maintain the internal generator batteries.
6. When using a Generator in an Off-Grid situation, we recommend changing the **"Grid Mode"** to **"General Standard"** and changing the **"Grid Reconnect Time"** under the **"Sell Control"** tab of the Grid Setup menu to 30 seconds.
7. In the **"Connect"** tab under **"Reconnect"** and **"Normal connect"**, change the frequency to a range of 55Hz - 65Hz. Widening the range will reduce the number of disconnections from fluctuations in a generator's frequency.
8. Under the **"Grid Setup"** menu → **Limiters** → **Other**, make sure to check the **" GEN connected to Grid Input"** box.
9. If planning on using a wind turbine in conjunction with the Sol-Ark, the turbine must have a 48V charge controller with a dump load to prevent battery overcharging. This charge controller must be connected directly to the battery bank of the Sol-Ark.

Grid-Tie and No Battery Install Tips (Passthrough mode)

1. Under **"Battery setup"**, select **"No Battery"** & disable **"Activate Battery"** (the system will fault and start beeping).
2. **!** A complete **Power Cycle IS REQUIRED** when changing the battery mode to **"No Battery"** (see section 2.11 "Power Cycle Sequence" for detailed instructions).
3. Under **"Grid Setup"**, select **"Grid Sell"** and disable all other modes.
4. Touch the Battery Icon to see the Detailed Volts View to verify your inputs & outputs

4.1 Battery Charge Controller

4-Stage Charging

The MPPT has a 4-stage battery charging algorithm for rapid, efficient, and safe battery charging. The next figure shows the stage sequence.

Bulk Charge Stage

In the Bulk Charge stage, the battery is not at a 100% state of charge and has not yet reached the Absorption voltage setpoint. The controller will deliver 100% of available solar power to recharge the battery.

Absorption Stage

When the battery has reached the absorption voltage setpoint, the Sol-Ark inverter uses constant-voltage regulation to maintain battery voltage at the absorption setpoint, preventing overheating and excessive battery gassing. The battery is allowed to come to a full state of charge at the absorption voltage setpoint. Absorption lasts until the battery charge amperage (A) rate reaches 2% of the programmed capacity (Ah).

Float Stage

After the Absorption stage charges the battery fully, the MPPT reduces the battery voltage to the float voltage setpoint. If the batteries have 100% charge, there can be no more chemical reactions and all the charging current turns into heat and gassing. The Float stage provides a meager rate of maintenance charging while reducing the heating and gassing of a fully charged battery. The purpose of the Float stage is to protect the battery from long-term overcharge.

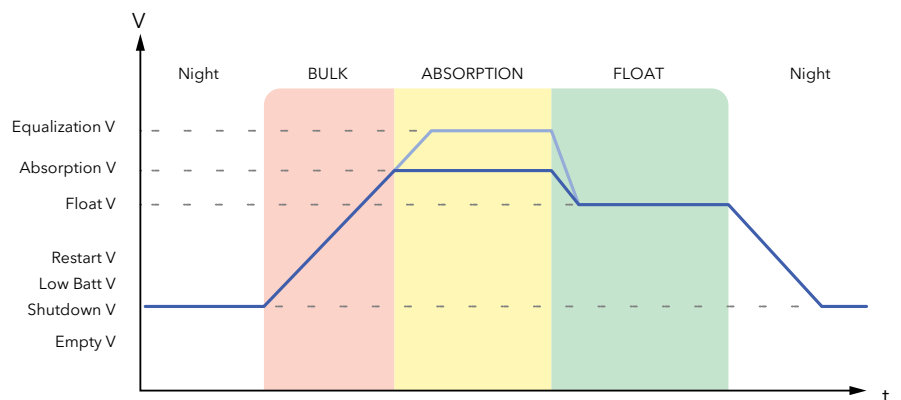

Figure 31: Charge controller curve

Battery Charging Setpoint Examples (48V Nominal)

Battery Type	Absorption	Float	Equalize (Every 30 days for 3hr)
AGM / PCC	57.6V	53.6V	57.6V
Gel	56.4V	54.0V	
Wet	59.0V	55.0V	59.0V
Lithium	54.6V	54.3V	-

⚠️ Follow all battery manufacturer-specified values to ensure proper charging and discharging

Calculating Battery Bank Amp-Hours Examples (AGM)

# of batteries	Voltage per Battery	Ah per battery	Ah @48V (Chain of 4 batteries of 12V in series)	Max Charge Discharge (A)
4	12V	230Ah	230Ah	100A
8	12V	230Ah	460Ah	120A
12	12V	230Ah	690Ah	120A

4.2 Battery Communication with MODBUS/CANBUS

⚠️ Any damage caused by the improper use of the communication protocols (CANBUS or MODBUS) will not be covered by warranty. Modbus map is available upon request for "READ" operations only. Contact technical support at support@sol-ark.com to obtain the MODBUS map.

RJ-45 Configurations

The Sol-Ark 5K-1P-N inverter achieves battery communications through a single RJ-45 port labeled "Battery CANBus". This port combines the RS-485 and CAN pin configurations shown below. Both "Modbus RS485" and "Battery CANBus" ports are capable of Modbus communication.

Pin	RS485	CAN
1	RS-485 B-	--
2	RS-485 A+	--
3	--	--
4	--	CAN Hi
5	--	CAN Lo
6	GND	GND
7	RS485 A+	--
8	RS485 B-	--

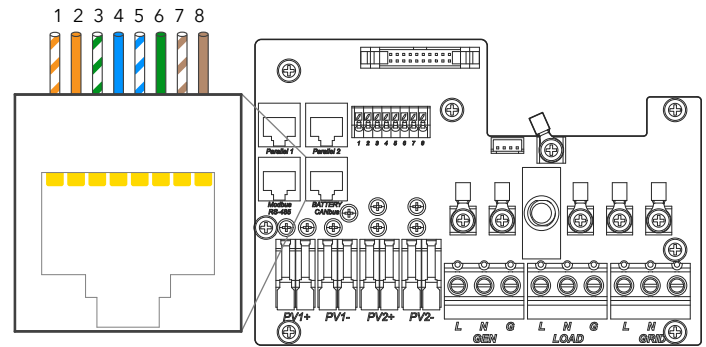

Figure 32: RJ-45 port configuration

! Complete battery integration guide of supported battery communications can be found at: www.sol-ark.com/battery-partners

External MODBUS Devices:

If an external device utilizes **BMS Lithium Batt 00**, one must change the **Modbus SN** of the inverter to **01** as the default value is 00.

4.3 Grid Compliance Settings

Puerto Rico Grid Compliance Settings

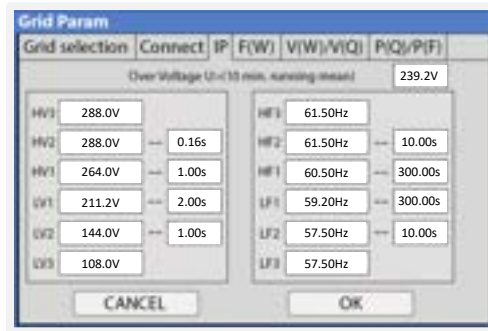

HECO Grid Compliance Settings

120/240V

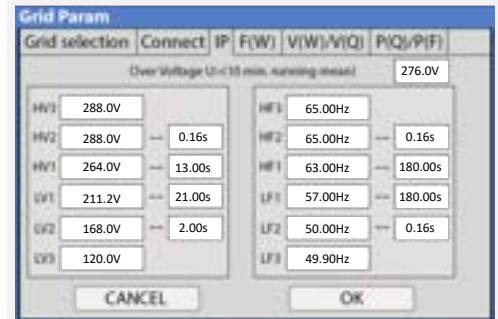
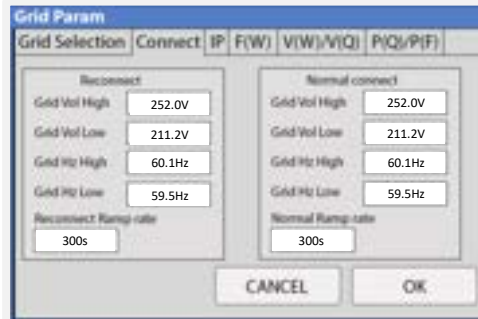

120/208V

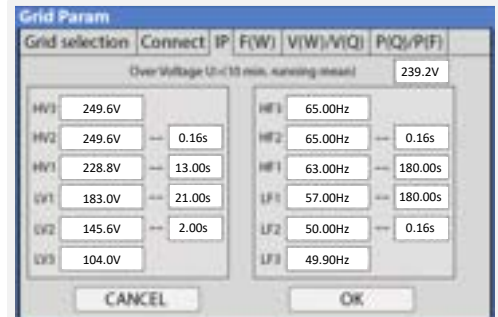
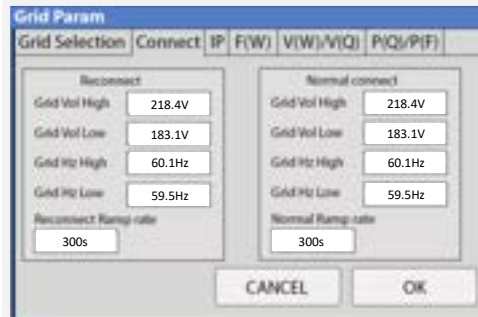

Frequency-Watt, Volt-Watt and Volt-Var

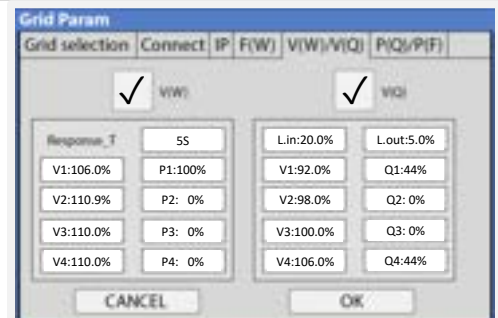
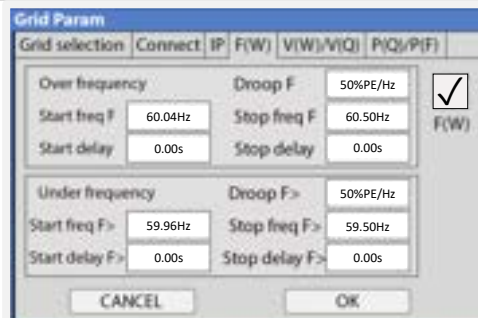

5. Parallel Systems

5.1 Before Enabling Parallel Operations

- A. Make sure all units in parallel have the same software version by verifying the **"COMM"** and **"MCU"** numbers on System Setup.
- B. Go to <https://www.sol-ark.com/software-update/> to schedule an update or call/email Tech Support for assistance: support@sol-ark.com
- C. ⚠️ Parallel systems **REQUIRE** a joint battery bank. If you do not have a battery, keep all Sol-Ark inverters **OUT** of parallel and set every System to **"Grid Sell"** Mode.
- D. All INPUTS/OUTPUTS must be shared among **ALL** parallel inverters, with the exception for DC solar inputs.

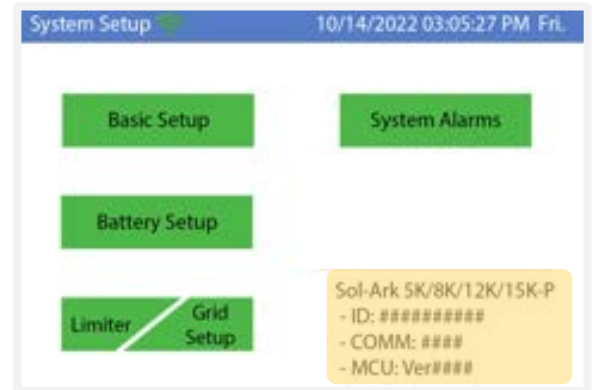

Figure 33: Software version check

DIP Switch Configuration for Parallel Systems

In parallel systems, set the "DIP Switches" shown in the following, according to the table below.

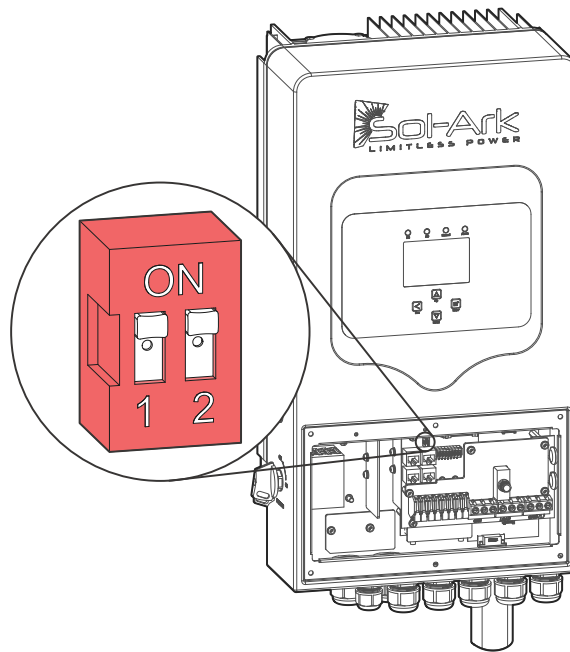

Figure 34: Sol-Ark DIP switches

Inverter 1 (Master)	Inverter 2	Inverter 3	Inverter 4	Inverter 5	Inverter 6	Inverter 7	Inverter 8
OFF							
! ON	! ON						
OFF	ON	OFF					
OFF	ON	ON	OFF				
OFF	ON	ON	ON	OFF			
OFF	ON	ON	ON	ON	OFF		
OFF	ON	ON	ON	ON	ON	OFF	
OFF	ON	ON	ON	ON	ON	ON	OFF

! Parallel systems with 2 inverters must have their DIP switches on the ON position

# of inverters in parallel	Continuous output power with PV (kW)	Continuous output power with batteries (kW)	Grid "Pass Through" (A)	Peak power 5 sec (kVA)
1	4.8	4.8	50	10
2	9.6	9.6	100	20
3	14.4	14.4	150	30
4	19.2	19.2	200	40
5	24	24	250	50
6	28.8	28.8	300	60
7	33.6	33.6	350	70
8	38.4	38.4	400	80

5.2 Parallel Systems Programming Sequence

1. Program each one of the units for parallel under "Basic Setup" → Parallel".
2. Assign a System as "**Master**" | **Modbus SN: 1**
3. Assign all other units as "**Slave**" | **Modbus SN: 2,3,4...etc.**
4. Connect communication cables between the inverters using the RJ45 cable (yellow ethernet cable) in daisy-chain configuration between ports: "Parallel 1" or "Parallel 2" from Master into Slave.
5. Perform a power cycle (see section 2.11 "Power Cycle Sequence" for power cycle sequence instructions).
6. Once shut down completely, turn on the "Slave" units **FIRST** working backwards. Then turn ON the "Master" **LAST**.
7. Inverters will likely fault momentarily with F29 and F41 codes until all inverters are ON.
8. REMEMBER: All inverters must be connected to the **SAME BATTERY BANK**.

i When integrating a generator, it must be connected to all the systems in parallel. The inverter assigned as "Master" will control the two-wire start feature

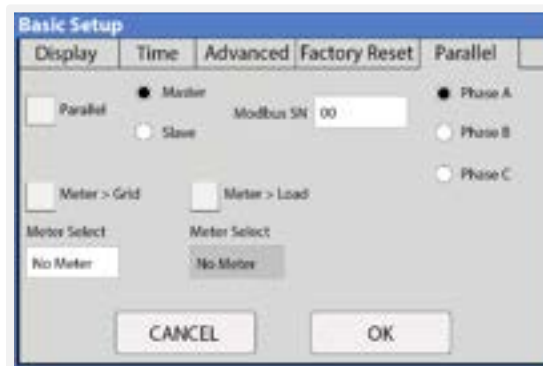

Figure 35: Parallel setup tab

i If an inverter goes into a fault state, all other units will stop and follow. The system will automatically self-reboot. If the system faults 5 consecutive times, it will stop completely and it will require a manual restart. See section 2.12 "Power cycle sequence" for detailed instructions.

6. Wi-Fi / Ethernet Connection

6.1 Ethernet Connection

- Remove the plastic enclosure of the dongle by pressing the plastic latches with a flat screwdriver as shown in the following figure.
- Insert the ethernet cable through the plastic enclosure and connect the cable to the RJ45 port.
- Reassemble the dongle housing and plug the dongle into the Sol-Ark. Secure with screws (see figure 37). You will see solid red and green lights after a couple of minutes.
- Follow "STEP 1" instructions on the following page in order to create a plant on our monitoring platform.

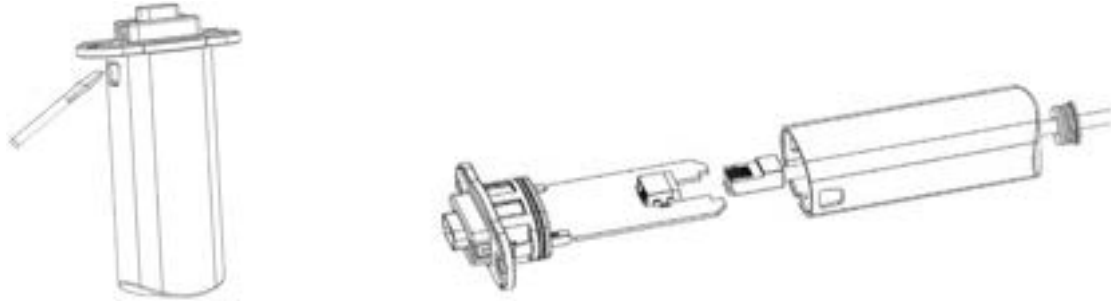

Figure 36: Connecting Wi-Fi dongle to ethernet

6.2 Wi-Fi (PC or Smart Phone)

- Plug the Wi-Fi dongle into Sol-Ark DB-9 port.
- Use two M4X10 screws to secure the dongle as shown below.
- A solid red LED will light up, indicating the dongle is being powered.
- Follow the next set of instructions in order to:
 - Create a plant on the Sol-Ark monitoring platform
 - Connect the Wi-Fi dongle to the internet for remote monitoring

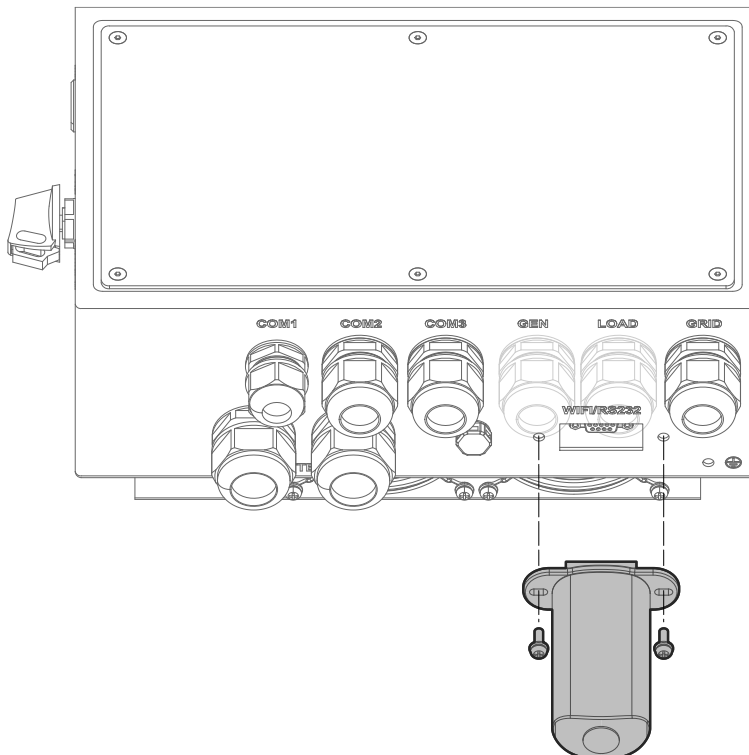

Figure 37: Connecting Wi-Fi dongle to Sol-Ark 5K-1P-N

STEP 1: Create a "Plant"

A. Download the app for smart phones - "PV Pro"



a) iPhone IOS



b) Android



Installers

It is recommended that the installer creates the plant and share it later with MANAGER permission to the owner of the system. Once created, the installer or the homeowner can share the plant and assign Manager permissions on "My Plants" → "... " → "Share" → "Add Account".

TIP: If you want to share a plant, a PowerView account with the new email must be created.

B. Create PowerView / PV Pro account and login.

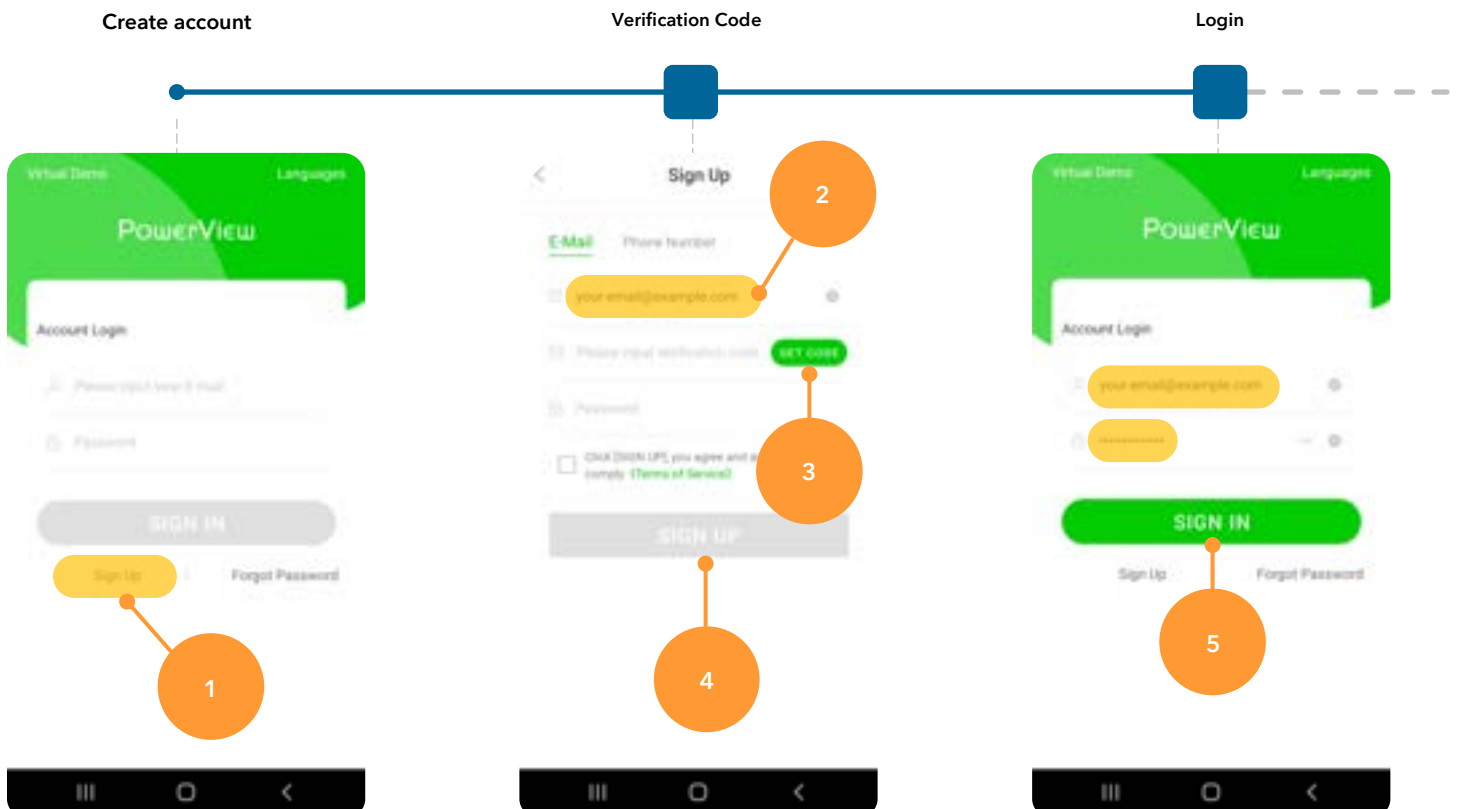

C. Create Plant.

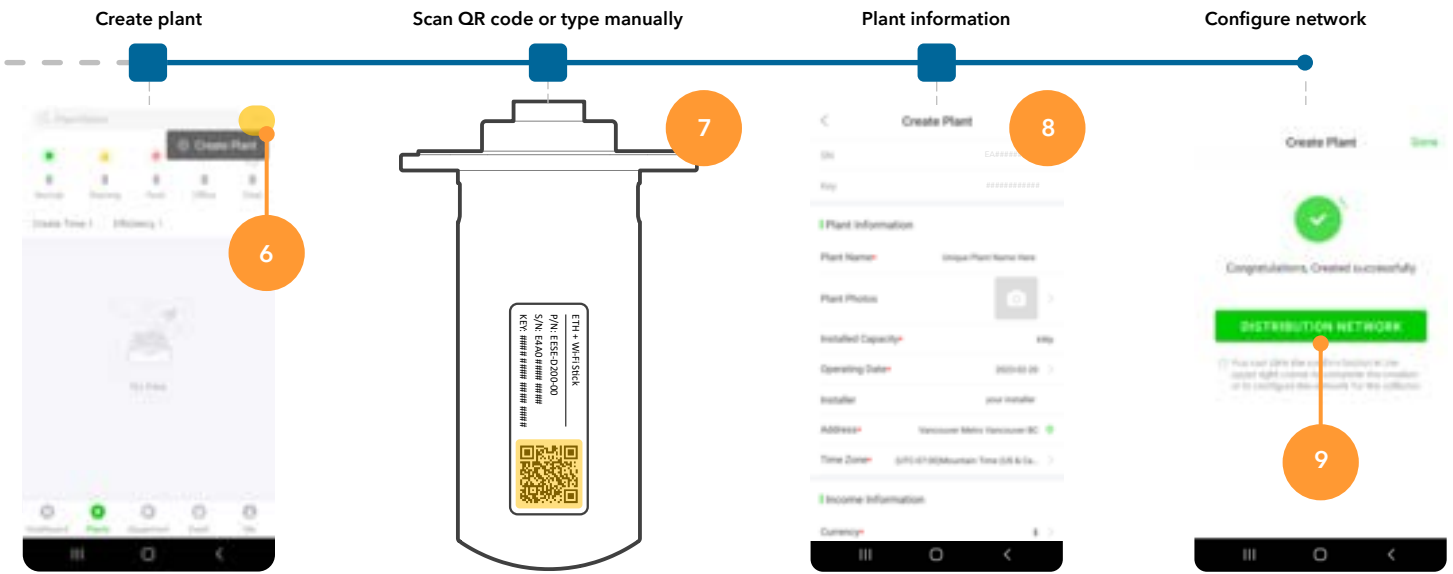

STEP 2: Configure Wi-Fi network though PV Pro

D. Configure Wi-Fi network.

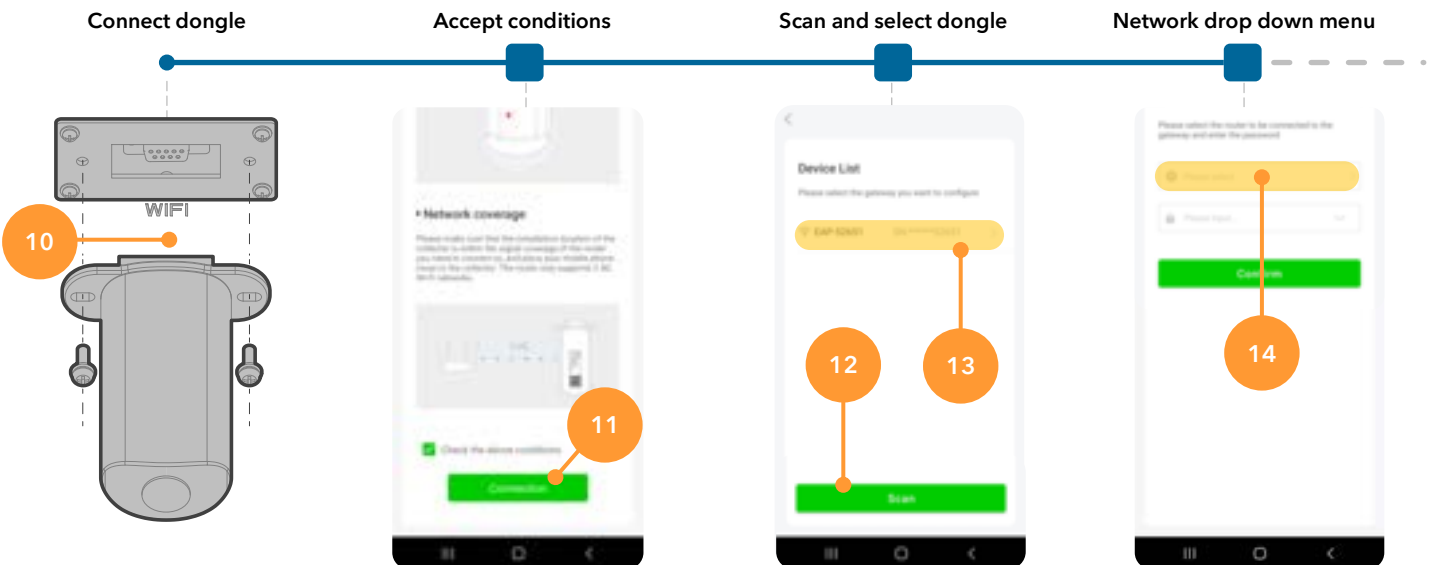

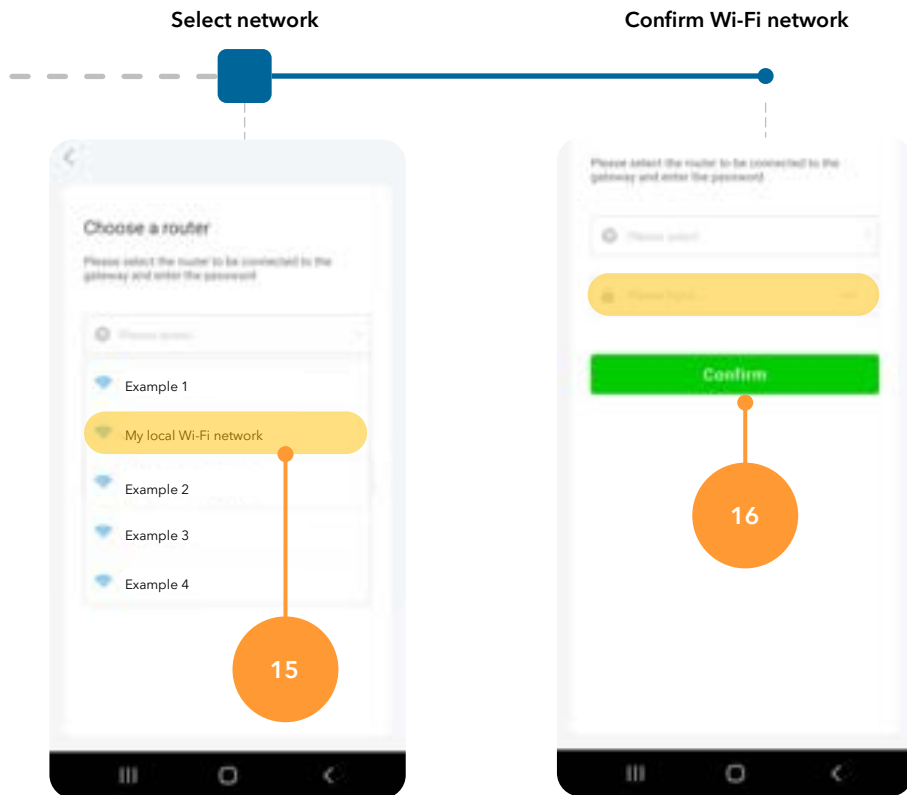

STEP 3 (Optional): Configure Wi-Fi Network Through IP Address

- If setting up a Wi-Fi connection through the "Distribution Network" at the end of step C was skipped, you can still configure a Wi-Fi network through an IP address.
- On your Smart Phone or Computer go to: **Settings** → **Wi-Fi** → Select the **EAP-####** network → **Password= 12345678**
 - The EAP-#### network contains the last 5 digits of the Dongle Serial Number. You can find this number on the label.
- Once your device is connected to the Dongle you will get the following message ("Connected without internet").

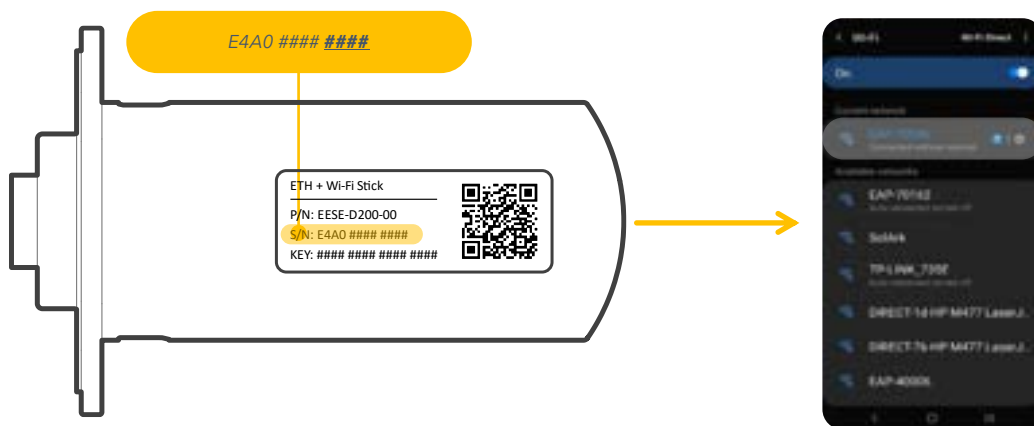
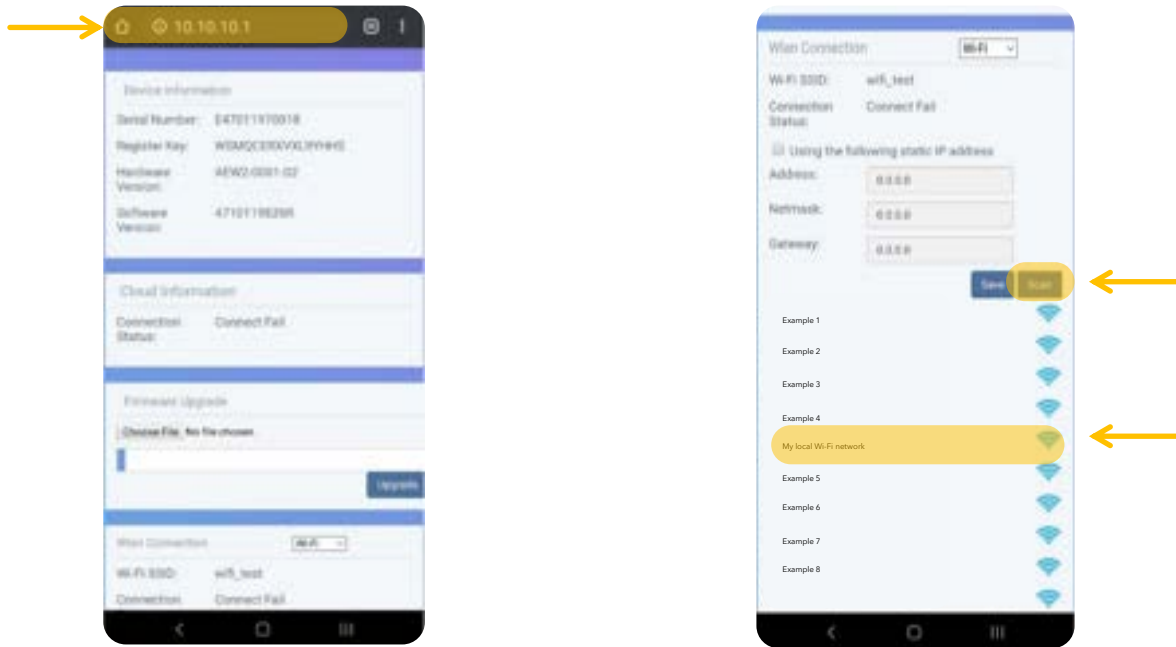

Figure 38: E4A0-#### serial number and EAP network

NOTE: The Wi-Fi dongle does NOT provide internet access. It needs an external internet provider to connect to. The dongle is compatible with Wi-Fi signal broadcasted at 2.4 GHz (*it is not possible to use 5 GHz*)

- D. Once your device is connected to the dongle, open an internet browser (Safari, Google, Chrome, etc.)
- E. On the address bar (http://.....), type the following IP address: **10.10.10.1** as shown in the figure below. If you can't access the configuration page, try again with a different device or computer.
- F. Scroll down to the "Wlan Connection" section.
- G. Press the "Scan" button to search local networks.
- H. Select Home network and input personal credentials.
- I. Select "Connect".
- J. **Do NOT select the EAP-#### network as that is the dongle itself.**



a) Internet browser IP address

Figure 39: IP address setup page

b) Wi-Fi network scan

- K. Press "Save" to save your information.
- L. Wait a moment (5 min) for the dongle to connect to the router and the server.

If successful, you should see a red and green light on the dongle showing a solid connection.

- o **RED LED:** Connected to Sol-Ark and has power.
- o **GREEN LED:** Connected to router and server.
- o **FLASHING GREEN LED:** Connected to router but not server (usually a VPN or Firewall issue, ports 80 and 51100 must be enabled).

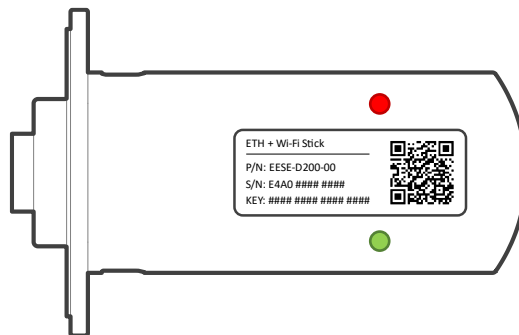

Figure 40: Wi-Fi dongle LED indicators

! Connecting the Wi-Fi dongle using the IP address 10.10.10.1 to your home Wi-Fi network is only meant to provide internet access to the inverter. **You must still create a PowerView account**

You can access PowerView on a computer with the following link:

www.mysol-ark.com

7. Wiring Diagrams

⚠️ These wiring diagrams are examples of common use-cases for Sol-Ark inverters. Diagrams must meet local electrical code and authorized jurisdiction requirements. Sol-Ark does not provide custom diagrams; however, you may contact support@sol-ark.com for questions about existing diagrams

Sol-Ark 5K-1P-N
Standard Wiring Diagram

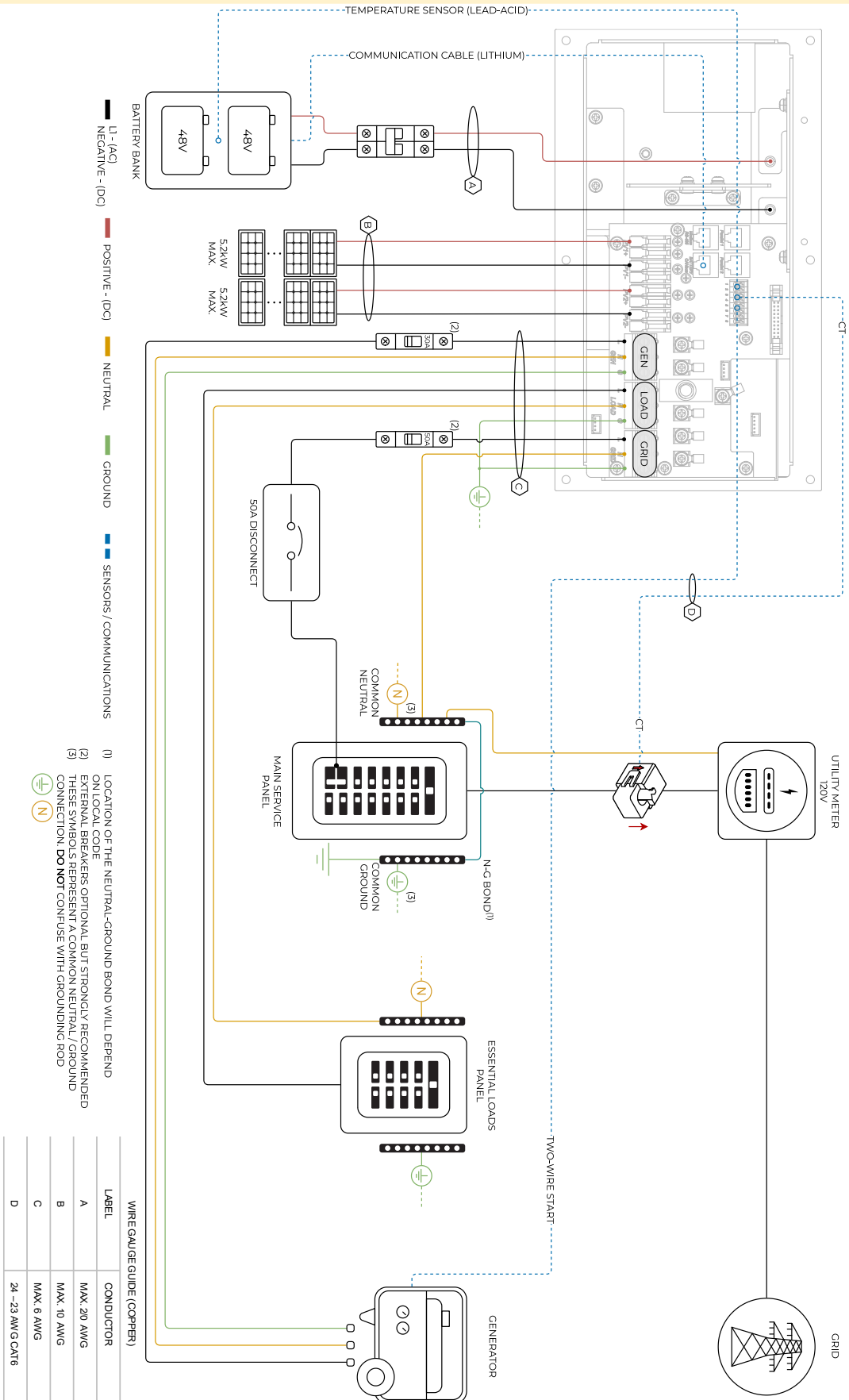

Diagram 01

Sol-Ark 5K-1P-N Standard Wiring Diagram – Line Side Tap

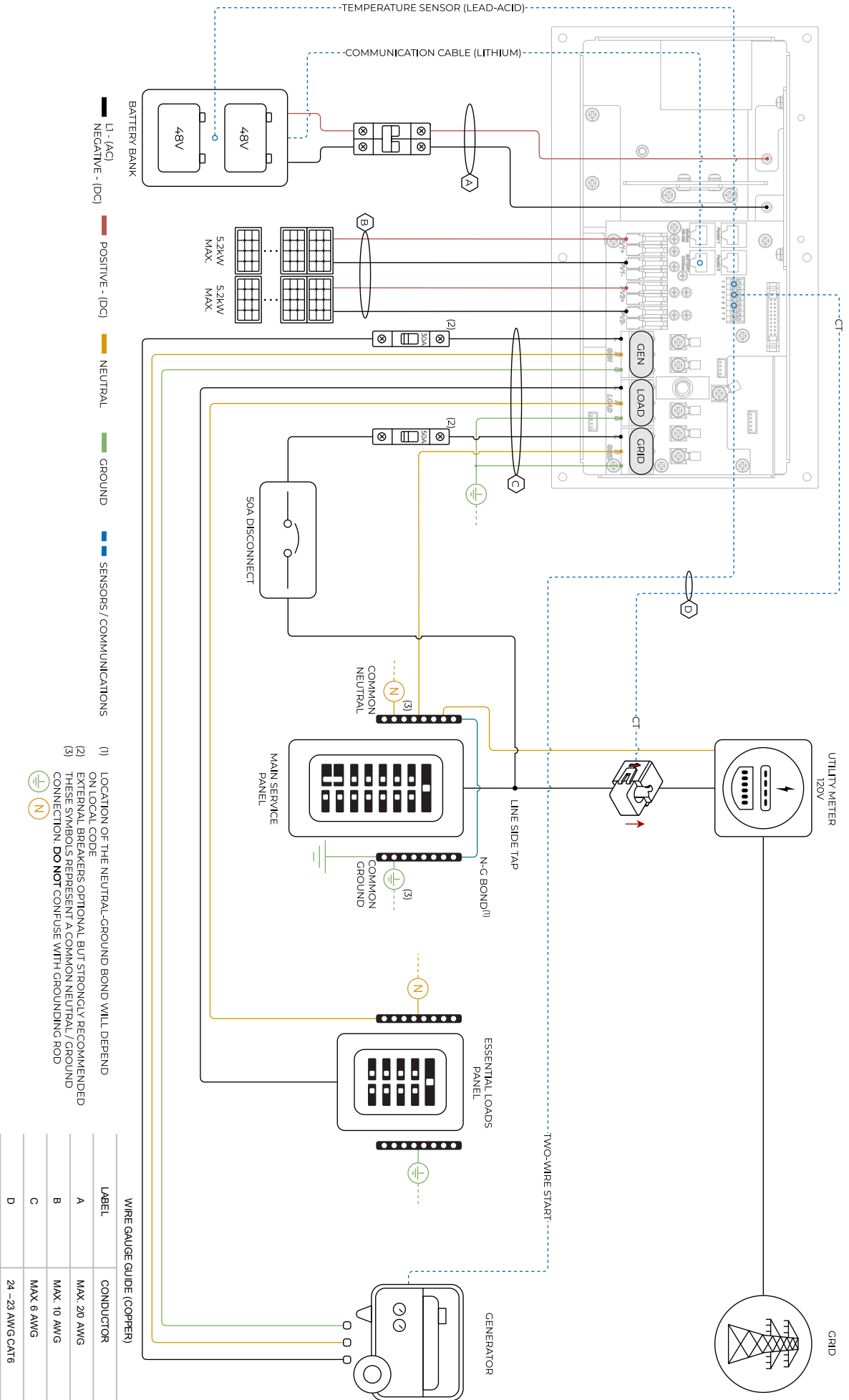

Diagram 02

Sol-Ark 5K-1P-N Standard Wiring Diagram - AC Coupling in GEN

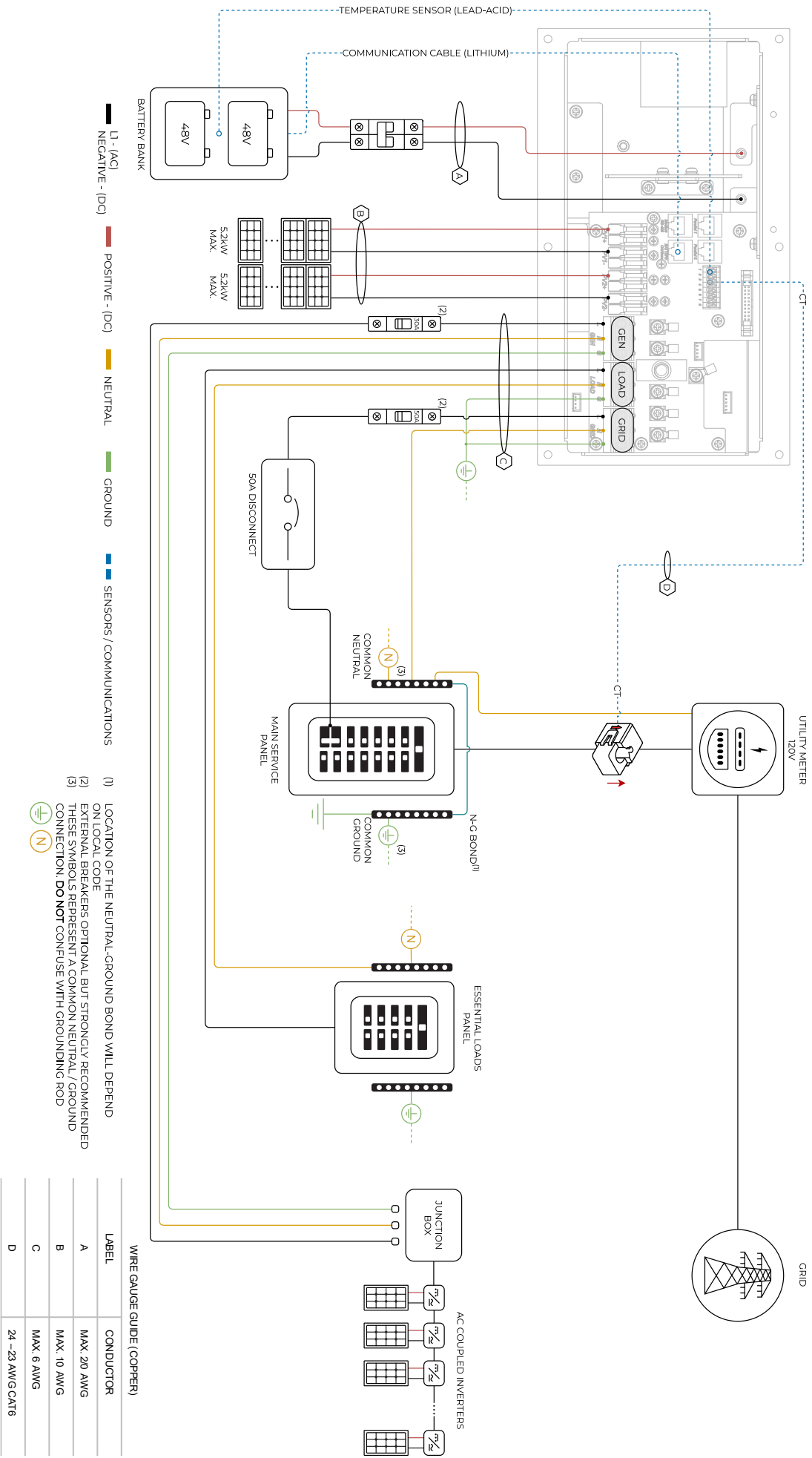

Diagram 03

Sol-Ark 5K-1P-N Standard Wiring Diagram - AC Coupling in LOAD

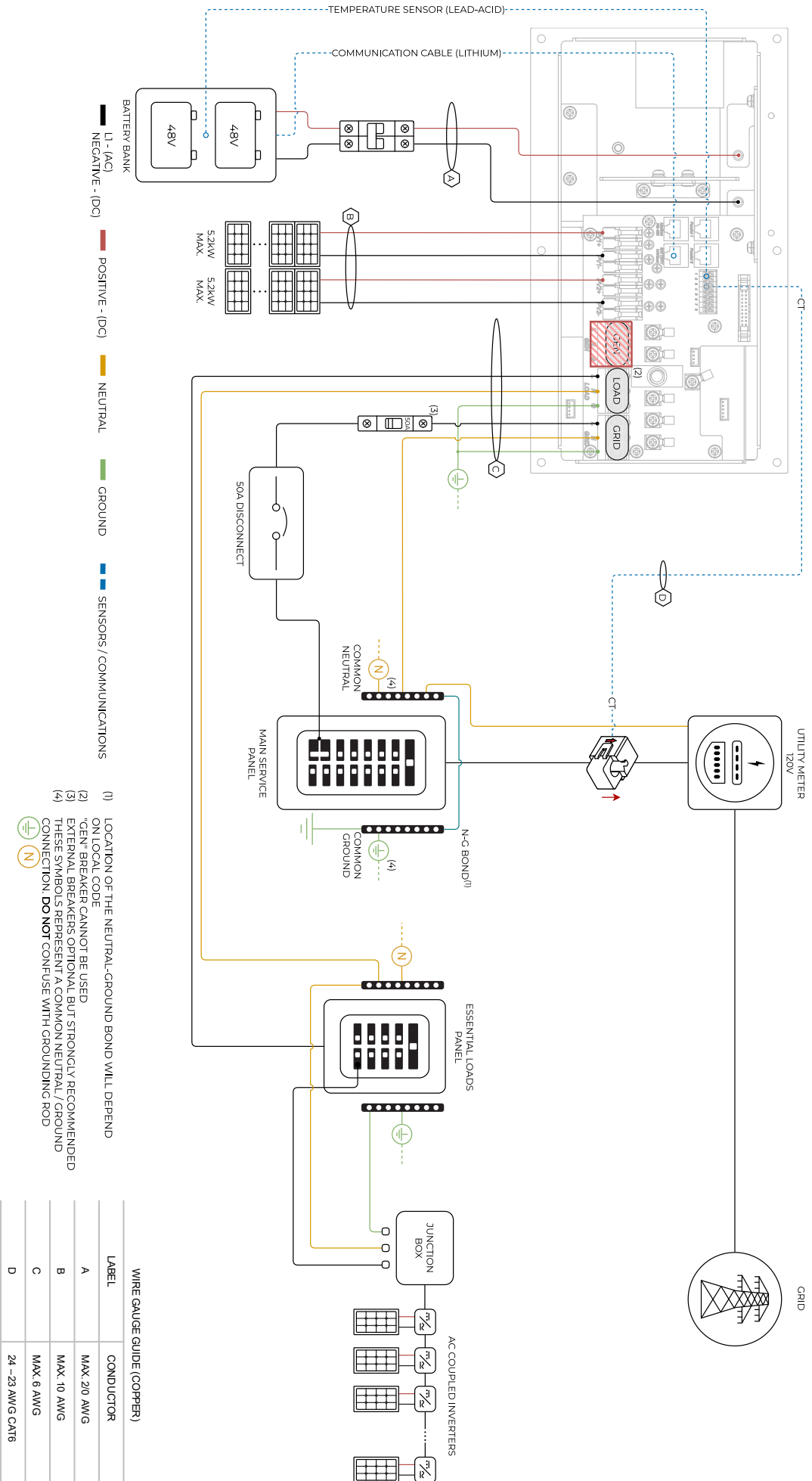

Diagram 04

Standard Wiring Diagram – Whole-Home Generator

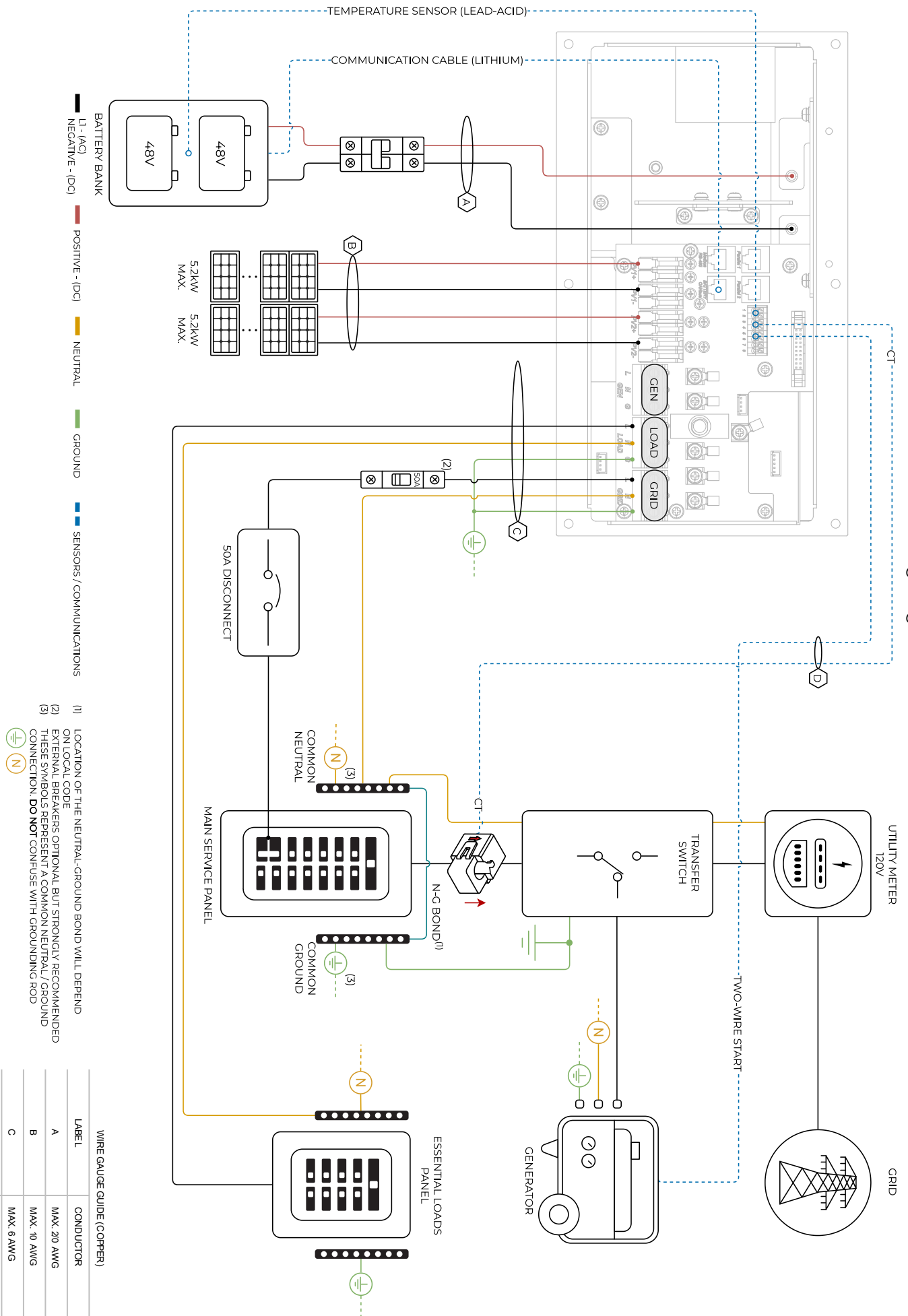

Diagram 05

Sol-Ark 5K-1P-N Standard Wiring Diagram - Off Grid

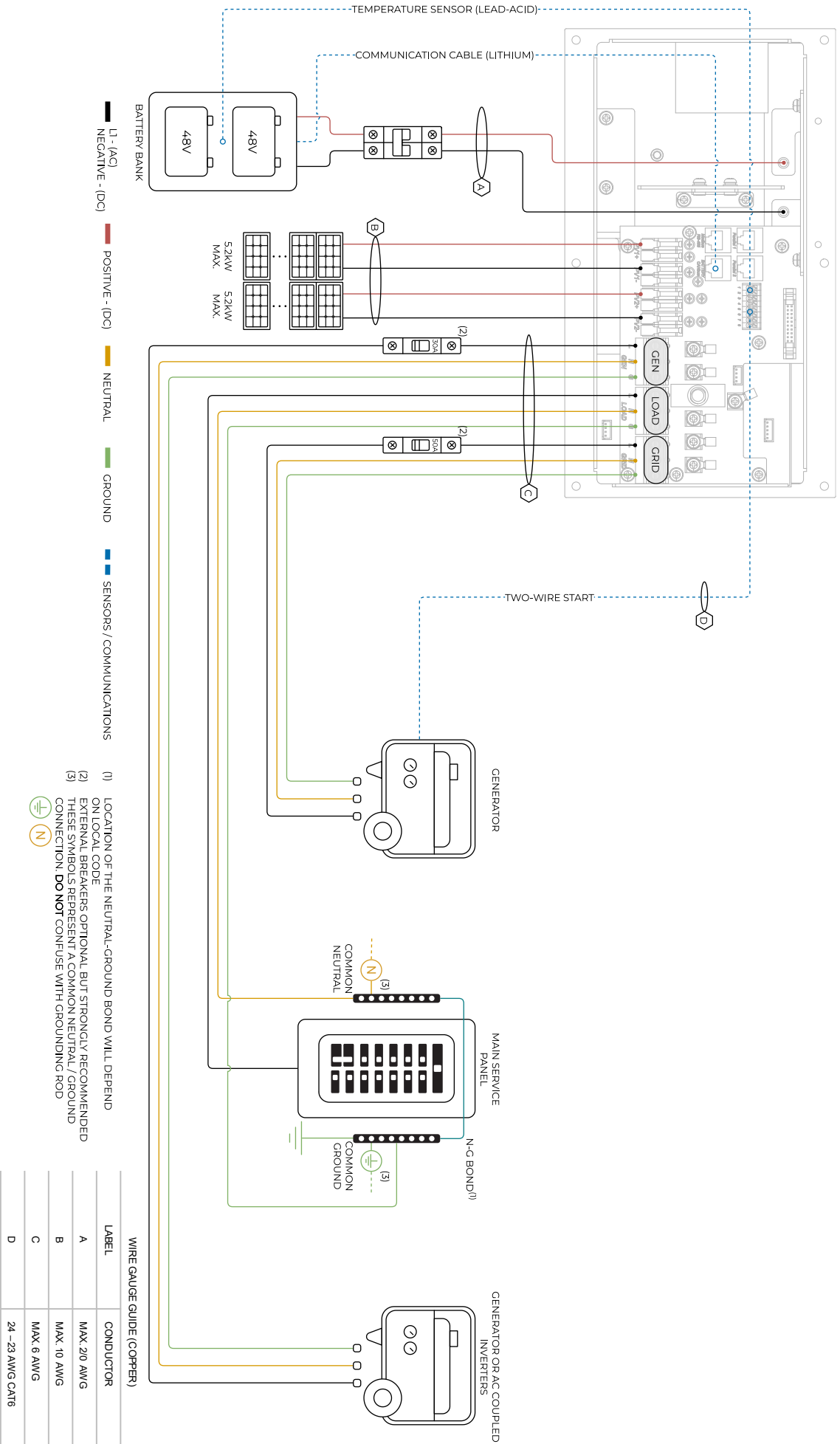
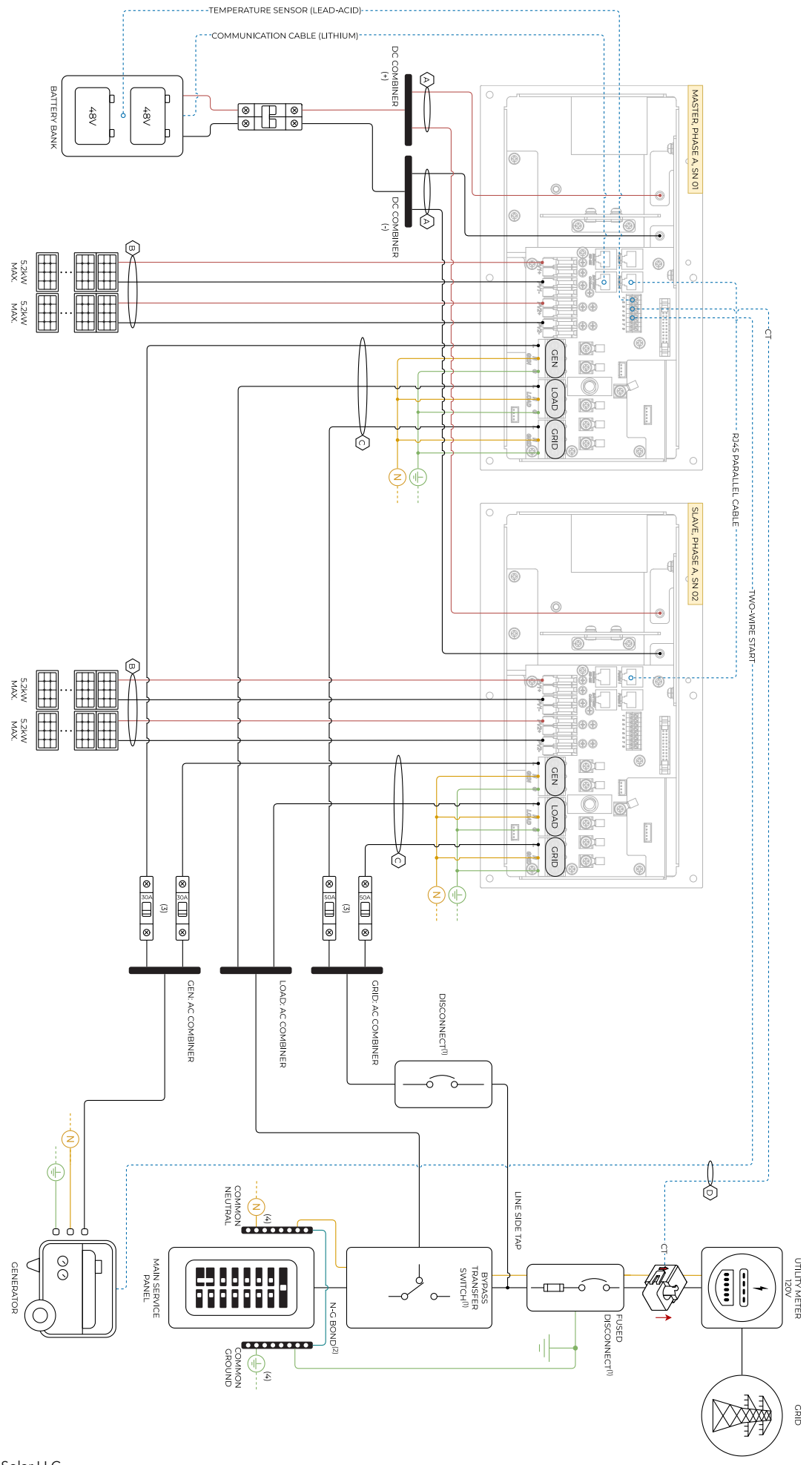

Diagram 06

Sol-Ark 5K-1P-N Standard Wiring Diagram – 2 Parallel Inverters



- L1 - (AC)
- POSITIVE - (DC)
- NEUTRAL
- GROUND
- SENSORS / COMMUNICATIONS
- NEGATIVE - (DC)

- (1) SIZE OF DISCONNECT / BYPASS SWITCH WILL DEPEND ON REQUIRE PASTTHROUGH CURRENT AND LOCAL CODE REQUIREMENTS
- (2) LOCATION OF THE NEUTRAL-GROUND BOND WILL DEPEND ON LOCAL CODE
- (3) EXTERNAL BREAKERS OPTIONAL, BUT STRONGLY RECOMMENDED
- (4) THESE SYMBOLS REPRESENT A COMMON NEUTRAL / GROUND CONNECTION. **DO NOT** CONFUSE WITH GROUNDING ROD

WIRE GAUGE GUIDE (COPPER)

LABEL	CONDUCTOR
A	MAX. 20 AWG
B	MAX. 10 AWG
C	MAX. 6 AWG
D	24 - 23 AWG CAT6

i Before powering up Parallel System installs, please see section 5 "Parallel Systems"

Diagram 07

Standard Wiring Diagram – 3 Parallel Inverters

Sol-Ark 5K-1P-N

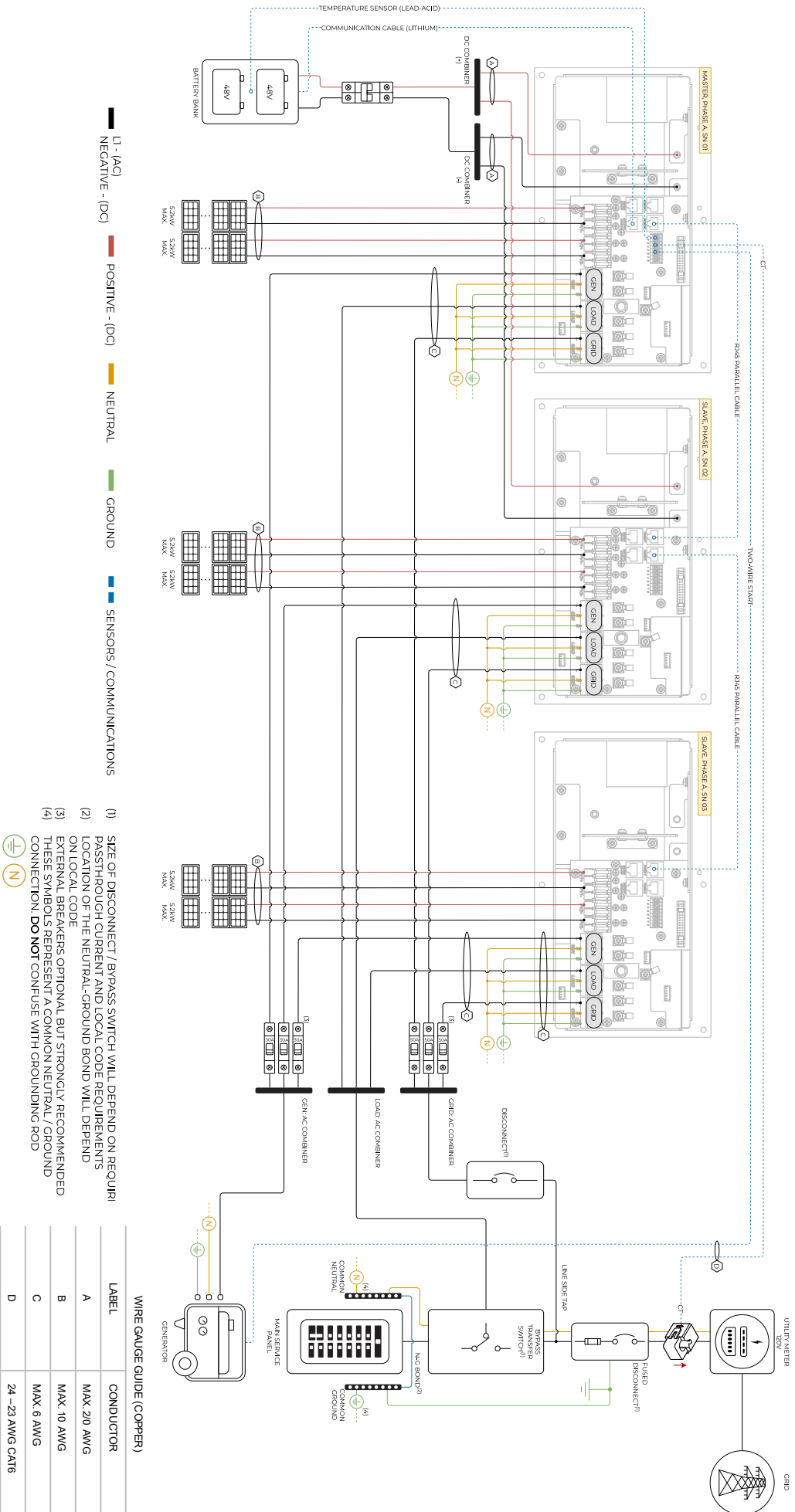

- (1) SIZE OF DISCONNECT / BYPASS SWITCH WILL DEPEND ON REQUIREMENTS
 - (2) PASSTHROUGH CURRENT AND LOCAL CODE REQUIREMENTS
 - (3) LOCATION OF THE NEUTRAL-GROUND BOND WILL DEPEND ON LOCAL CODE
 - (4) EXTERNAL BREAKERS OPTIONAL BUT STRONGLY RECOMMENDED
- THESE SYMBOLS REPRESENT A COMMON NEUTRAL / GROUND CONNECTION. **DO NOT** CONFUSE WITH GROUNDING ROD

Diagram 08

i Before powering up Parallel System installs, please see section 5 "Parallel Systems"

8. Troubleshooting Guide

LCD is not powering on

- Check all connections - at least one of the following power sources is required: PV/Grid/Battery
- Try pressing the power button, touchscreen, or navigation buttons

Panels are connected, but "DC" LED indicator is not on

- Minimum starting voltage is 125V. Voltage must be above 125V and below 500V
- Wrong polarity. Check string polarity on MPPT
- PV DC disconnect is not on the ON position

Panels are not producing

- Check for proper wiring on all solar panel connections
- Turn PV disconnect "ON"
- Check that the PV input voltage is not greater than 500V
- If the system measures 0V even when PV DC disconnect is ON, polarity might be wrong. Check PV polarity

Panels are not producing much power

- PV Wire Strip Length: 5/8". Your batteries are charged and is limited to house loads; you can test Grid Sell to verify.

The system does not keep batteries charged

- Check the charge setting in the Charge Menu

Auto Gen-Start is not working

- Check to make sure your generator is compatible with Auto Start
- Make sure that the Auto Gen Start wire is adequately connected to the Sol-Ark 15K and the generator

"Normal" LED indicator is not on

- Sol-Ark is in pass-through-only mode, only a Grid connection
- Not fully energized (DC Solar panels AND Grid or just batteries)
- In alarm state.
- Sol-Ark is not working correctly (Call technical support +1 (972) 575-8875 Ext. 2)

The "Alarm" LED indicator is on

- Check the system alarms menu to identify the alarm

Grid HM value is negative when it should be positive (only applies in Limited to Home mode)

- Limiter Sensors are backwards, L1/L2 sensors are swapped, or incorrectly wired L1/L2 sensors. Execute the "Auto Learn Home Limit Sensors" command described in section 2.9 "Limit Sensors, Automatic CT Limit Sensors Configuration"

AC Overload Fault or Bus Unbalance Fault

- Check Transfer Switch/Subpanel wiring
- Check for large loads that consume more than the inverter rating (EX: AC units over 3 tons)

The system connects to grid and quickly disconnects

- Verify your Neutral wire connection (should be 0Vac referenced to GND)
- Check your Freq is set to 60Hz, and the 15K measures 120V on L1 vs. N / L2 vs. N
- If overloading: verify 120V/240V grid input and load output wires are not swapped

DC Overload Fault

- Check PV voltage
- Make sure you have not wired more than two (2) solar strings in parallel per MPPT

System is beeping

- Check the System Alarms menu to see which alarm has been triggered. Most alarms will self-reset.
- There is no battery connected. If not using a battery, select "No Battery" and disable "Activate Batt" in Batt menu.
- Execute a Power Cycle

Battery cable sparks when connected

- If applicable, flip the built-in breaker of the battery to the OFF position before connecting or disconnecting batteries.

Battery symbol on the home screen is red

- The battery is below the empty voltage
- Battery is over-voltage

Battery symbol on the home screen is yellow

- The battery is low, or the charge/discharge current is close to the programmed limit

Grid symbol on the home screen is yellow

- Grid parameters are out of specified operating range
- There is a grid outage and there is no voltage on the GRID breaker
- System is Off-Grid

System has restarted

- Occurs if the system is overloaded, battery voltage is greater than 63V, or Software update

Batteries were connected backwards

-  System will be damaged, and warranty will be lost

Why is the LCD screen still on when the power button is off?

- If PV or Grid power is connected, LCD stays on, but the inverter and loads are off

The Batt SOC% is not reaching 100%

- The Sol-Ark might be in the calibration phase and estimating the battery SOC. We suggest waiting three full days to let the unit go through the 4-stage charging curve to converge to an accurate %
- If the suggestion above does not work, you can re-adjust the battery capacity under "Battery Setup" → "Batt Capacity" to restart the calibration process

Generator setup is reading 0Hz

- Generator frequency is out of frequency range. Select "General Standard" instead of UL1741. Then widen the frequency range to 55Hz-65Hz

Color Touchscreen is Frozen

- Press and hold the escape button [◀] for 7-10 seconds
- Perform a power cycle sequence in case the above suggestion does not work. See section 2.11 "Power Cycle Sequence"

8.1 Sol-Ark Error Codes

FAULT	INSTRUCTION	COMMON CAUSE / REMEDY
F1	DC_Inversed_Failure	If you have parallel systems and turn one system off, you will get this notification. NOT a fault.
F8	GFDI_Relay_Failure	Check for continuity on the inverter's neutral and ground. Ensure there is only ONE neutral-to-ground bond in the system. Current Leakage from inverter AC output to Ground, check Ground and neutral are connected at the main panel.
F13	Grid_Mode_change	It can happen when not using batteries or if Grid Input settings are changed. This is a notification, NOT a fault. If you switch from No Batt to Battery mode, power the system down completely to restart.
F15	AC_OverCurr_Failure	It is usually caused by Loads too large for the inverter. If Off-Grid, the battery discharge Amps are programmed too low. Overloads can result in F15, F18, F20, or F26.
F16	GFCI_Failure	Ground fault. Check PV+ or PV- wiring (which must be ungrounded). Exposed PV conductors + rain can also cause. Check that the neutral line and Ground are not double-bonded (common with portable generators).
F18	Tz_AC_OverCurr_Fault	Overloaded the Load Output (reduce loads) or overloaded a generator (reduce Gen Start A). Wiring Short on the AC Side can also cause this error. Overloads can result in F15, F18, F20, or F26.
F20	Tz_Dc_OverCurr_Fault	It is typically caused by DC current from the battery that is too large (ex: 4 Ton AC Unit) or too much PV current (3 or more strings in parallel). Overloads can result in F15, F18, F20, or F26.
F22	Tz_EmergStop_Fault	Initiated Emergency Stop; see sensor pinout table.
F24	DC_Insulation_Fault	An exposed PV conductor combined with moisture is faulting (can cause F16, F24, and F26).
F25	DC_Feedback_Fault	No battery connection to the Inverter and Activate Battery is enabled. Disable Activate Battery in settings while no battery is connected.
F26	BusUnbalance_Fault	Too much load on one leg (L1 or L2) vs. the other leg or DC loads on the AC output when Off-Grid. Grounded PV+/- wire can cause F20, F23, or F26.
F29	Parallel_CANBus_Fault	Usually, a communication error for parallel systems. Check cables, and MODBUS addresses.
F31	Soft_Start_Failed	Soft Start of the large motor failed.
F34	AC_Overload_Fault	AC Overload or load shorted. Reduce heavy loads.
F35	AC_NoUtility_Fault	Grid connection lost.
F37	DCLLC_Soft_Over_Cur	Software DC overcurrent.
F39	DCLLC_Over_Current	Hardware DC overcurrent.
F40	Batt_Over_Current	Batteries exceeded their current discharge limit.
F41	Parallel_System_Stop_Fault	If one system faults in parallel, this normal fault will register on the other units as they disconnect from the grid.
F45	AC_UV_OverVolt_Fault	Grid under voltage causes a disconnect. This will self-reset when the grid stabilizes.
F46	Battery_Backup_Fault	Cannot communicate with other parallel systems. Check Master = 1, Slaves = 2-9 and that ethernet are connected.
F47	AC_OverFreq_Fault	Grid over Frequency (common in power outages) causes disconnect. Will self-reset when grid stabilizes.
F48	AC_UnderFreq_Fault	Grid under Frequency (common in power outages) causes a disconnect. Will self-reset when grid stabilizes.
F55	DC_VoltHigh_Fault	PV may be higher than 500V. Battery voltage should not be above 59V or 63V (depending on the model).
F56	DC_VoltLow_Fault	Batteries are overly discharged, the inverter is Off-Grid and exceeded the programmed batt discharge current by 20%, or Lithium BMS has shut down. If battery settings are incorrect, this can also happen.
F58	BMS_Communication Fault	Sol-Ark is programmed to BMS Lithium Battery Mode but cannot communicate with a BMS. BMS_Err_Stop is enabled, but cannot communicate with a battery BMS
F60	Gen_Volt_or_Fre_Fault	Generator Voltage or Frequency went outside the allowable range.
F61	Button_Manual_OFF	The parallel Slave system turned off without turning off the Master.
F63	Arc_Fault	It can be a poor PV connector / Connection. Or sometimes a false alarm due to powerful lightning storms.
F64	Heatsink_HighTemp_Fault	Check that the built-in fans are running; the ambient temperature may be too high. Ensure proper clearance.

9. Install Verification

9.1 Warranty Checklist

The installer must complete this form AFTER the system is operational



This checklist must be filled out and submitted to register your warranty. Please visit:
<https://www.sol-ark.com/register-your-sol-ark/>

1. Have you sent a wiring diagram of your installation to Sol-Ark for verification? (support@sol-ark.com)	Y / N
a. If not, Sol-Ark assumes no responsibility for any performance issues as a result of the installation. Sol-Ark is not responsible for any changes to the installation.	
2. Is the inverter installed in a location where the LCD screen is protected from direct sunlight and is there enough vertical and lateral clearance for proper heat dissipation?	Y / N
3. Are all the battery lugs properly tightened at the corresponding torque? (40 in-lb / 4.5 Nm)	Y / N
4. Based on the following checklist: <input type="checkbox"/> grid or generator connected <input type="checkbox"/> load panel(s) connected <input type="checkbox"/> "LOAD" and "GRID" breakers ON <input type="checkbox"/> batteries ON <input type="checkbox"/> PV DC disconnect ON <input type="checkbox"/> power button ON	
a. Did any breakers trip?	Y / N
b. Did the inverter overload?	Y / N
5. If you are experimenting problems, email a description and photographs to support@sol-ark.com including:	
a. Photograph of the "Details Screen" including the voltages measured by the inverter.	
b. Photographs of the Sol-Ark inverter, user wiring area and batteries.	
6. Load and solar production TEST: Press the battery icon to access the "Details Screen" and corroborate the following readings:	
a. In case of having lead-acid batteries, verify if the battery temperature sensor is measuring data.	Y / N
b. Test the system by powering on considerable loads at the essential loads panel (backup circuits). Are the solar panels generating enough power to match the load demand (provided there is enough sun)?	Y / N
c. Provided there is grid and excess solar production compared to load demand, enable " <input checked="" type="checkbox"/> Grid Sell" mode. Is the inverter selling power back to the grid? (Negative HM measurements for L1 and L2)	Y / N
• Enable " <input checked="" type="checkbox"/> Limited Power to Home" mode ONLY. Are the HM measurements approximating zero or are slightly positive? Are they canceling out the grid demand (Meter Zero)?	Y / N
• Have you verified that the limit sensors are correctly installed? The "Auto Detect Home Limit Sensors" function auto corrects mistakes in CT sensor wiring. Batteries are and 120/240V grid required. (See section 2.9 - "Automatic CT Limit Sensors Configuration" for details).	Y / N
7. Have you programed the correct capacity (Ah) for the battery bank and recommended Max A charge/discharge?	Y / N
8. Have you programed the recommended battery charge voltages from your battery manufacturer?	Y / N
9. Off-Grid TEST:	
a. Minding the max power output of the Sol-Ark, turn OFF the external AC grid disconnect so that the Sol-Ark operates in an Off-Grid mode. Are appliances still being powered?	Y / N
b. Follow by turning OFF the PV DC disconnect, running only on batteries. Are appliances still being powered?	Y / N
10. Have you followed the steps for setting up the Wi-Fi / Ethernet connection and registered the customer's system on our monitoring app?	Y / N
11. Provided there is a standby or portable generator installed:	Y / N
a. Have you programmed "General Standard" grid mode and reprogramed grid freq. range to 55-65Hz?	Y / N
b. Have you enabled " <input checked="" type="checkbox"/> Gen Charge" and adequately set the charge current "A"(DC) at which the batteries will be charged from the generator?	Y / N
12. If the system has EMP protection, have you installed the included small suppressors on essential appliance cords and big suppressors on solar panel wires?	Y / N

Installer name

Installer Signature

Date

Customer Name

Customer Signature

Date

9.2 Limited Warranty: Sol-Ark 5K-1P-N

10-Year Limited Warranty for SOL-ARK (Portable Solar LLC) Products. Sol-Ark provides a Ten-year (10) limited Warranty ("Warranty") against defects in materials and workmanship for its Sol-Ark products ("Product"). The term of this warranty begins on the Product(s) initial purchase date, or the date of receipt of the Product(s) by the end user, whichever is later. This must be indicated on the invoice, bill of sale from your installer. This warranty applies to the original Sol-Ark Product purchaser and is transferable only if the Product remains installed in the original use location. Please call Sol-Ark to let us know if you are selling your Home and give us name and contact of the new owner.

Contact: (USA) +1-972-575-8875

For Info/Purchasing:

sales@sol-ark.com | ext.1

For Tech Support/Warranty Claim:

support@sol-ark.com | ext.2

The warranty does not apply to any Product or Product part that has been modified or damaged by the following:

- Installation or Removal (examples: wrong voltage batteries, connecting batteries backward, damage due to water/rain to electronics, preventable damage to solar wires.)
- Alteration or Disassembly.
- Normal Wear and Tear.
- Accident or Abuse.
- Unauthorized Firmware updates/software updates or alterations to the software code.
- Corrosion.
- Lightning: unless using EMP hardened system, then Portable Solar will repair the product.
- Repair or service provided by an unauthorized repair facility.
- Operation or installation contrary to manufacturer product instructions.
- Fire, Floods, or Acts of Nature.
- Shipping or Transportation.
- Incidental or consequential damage caused by other components of the power system.
- Any product whose serial number has been altered, defaced, or removed.
- Any other event not foreseeable by Portable Solar, LLC

Sol-Ark (Portable Solar LLC) liability for any defective Product, or any Product part, shall be limited to the repair or replacement of the Product, at Portable Solar LLC discretion. Sol-Ark does not warrant or guarantee workmanship performed by any person or firm installing its Products. This warranty does not cover the costs of installation, removal, shipping (except as described below), or reinstallation of Products or parts of Products. LCD screen and fans are covered for 5 years from date of purchase.

THIS LIMITED WARRANTY IS THE EXCLUSIVE WARRANTY APPLICABLE TO SOL-ARK (PORTABLE SOLAR LLC) PRODUCTS. SOL-ARK EXPRESSLY DISCLAIMS ANY OTHER EXPRESS OR IMPLIED WARRANTIES OF ITS PRODUCTS. SOL-ARK ALSO EXPRESSLY LIMITS ITS LIABILITY IN THE EVENT OF A PRODUCT DEFECT TO REPAIR OR REPLACEMENT IN ACCORDANCE WITH THE TERMS OF THIS LIMITED WARRANTY AND EXCLUDES ALL LIABILITY FOR INCIDENTAL OR CONSEQUENTIAL DAMAGES, INCLUDING WITHOUT LIMITATION ANY LIABILITY FOR PRODUCTS NOT BEING AVAILABLE FOR USE OR LOST REVENUES OR PROFITS, EVEN IF IT IS MADE AWARE OF SUCH POTENTIAL DAMAGES.

Return Policy - No returns will be accepted without prior authorization and must include the Return Material Authorization (RMA) number. Please call and talk to one of our engineers to obtain this number at 972-575-8875 ex.2.

Return Material Authorization (RMA) A request for an RMA number requires all the following information: 1. Product model and serial number; 2. Proof-of-purchase in the form of a copy of the original Product purchase invoice or receipt confirming the Product model number and serial number; 3. Description of the problem; 4. Validation of problem by Technical Support, and 5. Shipping address for the repaired or replacement equipment. Upon receiving this information, the Sol-Ark representative can issue an RMA number. Any product that is returned must be brand new, in excellent condition and packaged in the original manufacturer's carton with all corresponding hardware and documentation. Returns must be shipped with prepaid freight and insured via the carrier of your choice to arrive back at Portable Solar within 30 days of your initial delivery or pick-up. **Shipping charges will not be refunded.** All returns are subject to a 35% restocking fee. **No returns will be accepted beyond 30 days of original delivery.** The value and cost of replacing any items missing (parts, manuals, etc.) will be deducted from the refund. If you have any questions regarding our return policy, please email us at sales@sol-ark.com or call us at the number above during regular (M-F) business hours.

Sol-Ark 5K-1P-N Install Operational Verification Checklist Questionnaire must be filled out, signed, and dated to secure full warranty coverage.

10. GUI Screens

Main Menu

Solar Today=53KWH Total=559.8KWH

55.2V

17.00 KW, -5.00 KW, 5.00 KW, -7.00 KW

Solar	Grid	INV	USP LD	Batt
0W	4654W	-4654W	0W	-4248W
M1: 0V	60.0Hz	60.0Hz	119V	59%
0.0A	116V	116V		54.23V
0W	39.6A	40.7A		-78.34A
M2: 0V	HM: 21W			23.0C
0.0A	LD: 4654W			
0W				

Gen	TEMP
0V	DC: 36.7C
0.0Hz	AC: 30.2C
0W	

System Setup 10/14/2022 03:05:27 PM Fri.

Basic Setup, System Alarms, Battery Setup, Li-Batt Info, Limiter, Grid Setup

Only w/ BMS Lithium Mode

Sol-Ark 5K/8K/12K/15K-P
- ID: #####
- COMM: ####
- MCU: Ver###

System Alarms 1/25/2021 03:05:27 PM Mon.

Alarms Code	Occurred
F13 Grid_Mode_changed	2021-01-13 11:22
F13 Grid_Mode_changed	2021-01-13 11:20

0.00 V	0.00 A	0.0 C	0%	0 Ah
0.0 V	0.0 V	0A	0A	0x00 0x00

Only w/ BMS Lithium Mode

1. 0.00V 0.00A 0.0C 0.0%	0.0V 0.0A 0.0C
2. 0.00V 0.00A 0.0C 0.0%	0.0V 0.0A 0.0C
3. 0.00V 0.00A 0.0C 0.0%	0.0V 0.0A 0.0C
4. 0.00V 0.00A 0.0C 0.0%	0.0V 0.0A 0.0C
5. 0.00V 0.00A 0.0C 0.0%	0.0V 0.0A 0.0C
6. 0.00V 0.00A 0.0C 0.0%	0.0V 0.0A 0.0C
7. 0.00V 0.00A 0.0C 0.0%	0.0V 0.0A 0.0C
8. 0.00V 0.00A 0.0C 0.0%	0.0V 0.0A 0.0C
9. 0.00V 0.00A 0.0C 0.0%	0.0V 0.0A 0.0C
10. 0.00V 0.00A 0.0C 0.0%	0.0V 0.0A 0.0C
11. 0.00V 0.00A 0.0C 0.0%	0.0V 0.0A 0.0C
12. 0.00V 0.00A 0.0C 0.0%	0.0V 0.0A 0.0C
13. 0.00V 0.00A 0.0C 0.0%	0.0V 0.0A 0.0C

Basic Setup

Basic Setup

Display Time Advanced Factory Reset Parallel

Brightness, Beep, Auto Dim 6005

CANCEL OK

Basic Setup

Display Time Advanced Factory Reset Parallel

Year Month Day: 2021 10 26

Hour Minute Second: 03 04 15

Seasons: Season 1 (1-1), Season 2 (4-1), Season 3 (8-1)

Year Month Day: 4-1 8-1 12-1

CANCEL OK

Basic Setup

Display Time Advanced Factory Reset Parallel

Solar Arc Fault ON, Clear Arc Fault

Gen Limit Power 15000W

Load Limit Power 15000W

Grid peak-shaving Power 15000W

Auto detect Home Limit Sensors CT ratio 2000

UPS Time 0ms

CANCEL OK

Basic Setup

Display Time Advanced Factory Reset Parallel

Factory Reset, System selfcheck, Lock out all changes, Test Mode, Lock Grid Charging & Limited

CANCEL OK

Basic Setup

Display Time Advanced Factory Reset Parallel

Parallel, Meter, Modbus SN 00, Phase A, Phase B, Phase C

Meter Select: No Meter, No Meter

CANCEL OK

Batt Setup

Batt Setup

Batt Charge Discharge Smart Load

Batt Capacity 400Ah Use Batt V Charged

Max A Charge 275A Use Batt % Charged

Max A Discharge 275A No Battery

TEMPCD -0mV/C/Cell BMS Lithium Batt 00

Activate Battery

CANCEL OK

Batt Setup

Batt Charge Discharge Smart Load

StartV 49.0V 49.0V Float V 55.7V

Start% 30% 50% Absorption V 56.0V

A 40A 100A Equalization V 56.0V

Gen Charge Grid Charge 30 Days 1.0 Hours

Generator Exercise Cycle Day & Time >> Mon 08 :00 20min

Gen Force CANCEL OK

Batt Setup

Batt Charge Discharge Smart Load

Shutdown 46.0V 20% Batt Resistance 8mOhms

Low Batt 47.5V 35% Batt Charge Efficiency 99.0%

Restart 52.0V 50%

Batt Empty V 47.0V BMS Ev. Stop

CANCEL OK

Batt Setup

Batt Charge Discharge Smart Load

Use gen input as load output For AC Coupled Input to Gen

On Grid always on High Freq. 62.00Hz

Smart Load OFF Batt 53.0V 80% AC couple on load side

Smart Load ON Batt 54.0V 80%

Solar Power(W) 500W

CANCEL OK

Limiter

Grid Param

Limiter Other

Grid Sell 15000

Time	Power(W)	Batt	Charge	Sell
01:00AM	2000	50%		
05:00AM	2000	50%		
09:00AM	2000	100%		
01:00PM	2000	100%		
05:00PM	2000	50%		
09:00PM	2000	50%		

Limited Power to Home

Limited Power to Load

Time of Use Solar

CANCEL OK

Time of Use Setup

Mon Tue Wed Thur

Fri Sat Sun

Season 1 Season 2 Season 3

CANCEL OK

Grid Param

Limiter Other

GEN connect to Grid Input

Zero Export Power 10W

Batt First Load First

CANCEL OK

Grid Setup

Grid Param

Grid Selection Connect IP F(W) V(W)/V(Q) P(Q)/P(F)

Grid Mode 3/3 Grid Reconnect Time 300s

UL1741SE Power Factor 1.000

Grid Frequency 60Hz 60Hz

Fixed Q 0%

Q Response 105

Single Phase Output V 120/208V

120/240V Split Phase Output V+ +0V

120/208V 3-Phase

CANCEL OK

Grid Param

Grid Selection Connect IP F(W) V(W)/V(Q) P(Q)/P(F)

Reconnect Normal connect

Grid Vol High 228.6V	Grid Vol High 249.6V
Grid Vol Low 183.2V	Grid Vol Low 194.0V
Grid Hz High 61.5Hz	Grid Hz High 62.0Hz
Grid Hz Low 58.5Hz	Grid Hz Low 57.0Hz

Reconnect Ramp rate 60s Normal Ramp rate 60s

CANCEL OK

Grid Param

Grid selection Connect IP F(W) V(W)/V(Q) P(Q)/P(F)

Over Voltage (t<10 min, averaging mean) 219.2V

HV1 249.5	HF1 62.00Hz
HV2 249.6V --- 0.1s	HF2 62.00Hz --- 0.1s
HV3 249.6V --- 11.0s	HF3 61.50Hz --- 299.0s
V1 183.0V --- 21.0s	LF1 58.50Hz --- 299.0s
V2 145.6V --- 2.0s	LF2 57.00Hz --- 0.1s
V3 104.0V	LF3 57.00Hz

CANCEL OK

Grid Param

Grid selection Connect IP F(W) V(W)/V(Q) P(Q)/P(F)

Over frequency Droop F 40%/PE/Hz F(W)

Start freq F 60.50Hz Stop freq F 60.50Hz

Start delay 0.00s Stop delay 0.00s

Under frequency Droop F-> 40%/PE/Hz

Start freq F-> 59.50Hz Stop freq F-> 59.50Hz

Start delay F-> 0.00s Stop delay F-> 0.00s

CANCEL OK

Grid Param

Grid selection Connect IP F(W) V(W)/V(Q) P(Q)/P(F)

V(W) V(Q)

Response_T	P1:100%	L1:20.0%	L1:5.0%
V1:109.0%	P1:100%	V1:90.0%	Q1:4.0%
V2:116.0%	P2:50%	V2:94.0%	Q2:0%
V3:111.0%	P3:0%	V3:106.0%	Q3:0%
V4:112.0%	P4:0%	V4:110.0%	Q4:4.0%

CANCEL OK

Grid Param

Grid selection Connect IP F(W) V(W)/V(Q) P(Q)/P(F)

P(Q) P(F)

P1:20%	Q1:20%	V1:50.0%	F1:1.000
P2:100%	Q2:20%	V2:100%	F2:0.800
P3:100%	Q3:20%	V3:100%	F3:0.800
P4:100%	Q4:20%	V4:100%	F4:0.800

CANCEL OK

