



INSTALLATION GUIDE AND USER MANUAL

Sol-Ark 15K-2P-N

RESIDENTIAL
NORTH AMERICA





READ THE INSTRUCTIONS COMPLETELY BEFORE OPERATING THE EQUIPMENT

Check the utility voltage before turning **ON** the unit.

Verify the inviter's programmed grid type before connecting to the utility.

The unit will be programmed in 120/240V Split-Phase at 60Hz by default.

Disregarding these instructions could result in permanent damages to the unit



DISCLAIMER

UNLESS SPECIFICALLY AGREED TO IN WRITING:

Sol-Ark assumes no responsibility or liability for any damages, property loss, personal injury, or any adverse consequences resulting from improper use and installation of the product or the failure to adhere to the guidelines provided in this document. Users are expressly advised to follow the instructions and guidelines outlined in the documentation accompanying the product. Sol-Ark shall not be liable for any damages or losses incurred due to deviations from recommended usage, installation, or maintenance procedures. By using the product, users acknowledge their understanding of these disclaimers and agree to use the product at their own risk. Sol-Ark reserves the right to update or modify product information, specifications, and guidelines without prior notice.

Sol-Ark retains the right to final interpretation of this document and all related materials pertaining to this product. This document is subject to modifications, updates, revisions, or termination without prior notice. For the latest product information, please visit Sol-Ark's official website. www.sol-ark.com

This manual is only for the **15K-2P-N Hybrid Inverter**.

For support, contact:

(USA) +1 (972) 575-8875 ext. (2)

support@sol-ark.com

Table of Contents

IMPORTANT SAFETY INSTRUCTIONS.....	5
1. Sol-Ark: At a First Glance	6
1.1 General Description	7
1.2 Specifications	8
1.3 Connection Requirements	10
2. Installation.....	11
2.1 Mounting the Sol-Ark.....	11
2.2 Integrating Batteries.....	13
2.3 Battery Communication.....	15
2.4 Connecting PV Modules.....	16
2.5 Integrating a Generator.....	17
2.6 Grid Peak Shaving	18
2.7 Automatic Generator Start.....	18
2.8 Integrating Sensors and Accessories	19
2.9 Limit Sensors (CT sensors).....	20
2.10 Emergency Stop and Rapid Shutdown.....	22
2.11 Powering-up and Testing the Sol-Ark.....	23
2.12 Power Cycle Sequence.....	23
3. User Interface.....	24
3.1 LED Indicators	24
3.2 Main Menus	24
3.3 Basic Setup	26
3.4 Battery Setup.....	27
3.5 Limiter.....	29
3.6 Grid Setup.....	33
4. Installation Tips	35
4.1 Battery Charge Controller.....	35
4.2 Grid Compliance Settings	36
5. Parallel Systems	37
5.1 Before Enabling Parallel Operations.....	37
5.2 Parallel Systems Programming Sequence.....	38
5.3 Three-Phase Systems	40
6. MySolArk: Remote Monitoring	42
6.1 MySolArk Setup Instructions.....	42
6.2 LED Indicator and troubleshooting	46
7. Wiring Diagrams	47
8. Troubleshooting Guide.....	58
8.1 Sol-Ark Error codes	60
9. Warranty Verification Checklist	61
10. GUI Screens	63

IMPORTANT SAFETY INSTRUCTIONS

SYMBOLS THAT APPEAR IN THIS DOCUMENT



WARNING: This symbol indicates information that, if ignored, could cause serious injury, equipment damage, or death.



CAUTION: This symbol indicates information that, if ignored, could result in minor injury or equipment damage.



NOTE: This symbol indicates relevant information that is not related to hazardous situations.

WARNINGS



Read this entire document before installing or using the Sol-Ark 15K-2P-N inverter. Failure to follow any of the instructions or warnings in this document can result in electrical shock, serious injury, or death. Damage to the 15K-2P-N inverter is also possible, potentially rendering it inoperable.



High Life Risk due to fire or electrocution - ONLY qualified persons should install the Sol-Ark inverter.



The system must have Ground connections and Neutral connections. Ground MUST be bonded to Neutral ONLY ONCE in the circuit.



Solar PV+/PV- are UNGROUNDED. Note, you may ground PV Racking/Mounts, but doing so directly to the Sol-Ark will likely result in damage in the case of a direct lightning strike to the PV array.



DO NOT connect the grid to the "LOAD" output terminal.



DO NOT reverse the polarity of batteries. Damage WILL occur.



DO NOT exceed 500V_{oc} on any MPPT on the Sol-Ark.



DO NOT turn off the battery breaker if there is current flowing in or out of the battery in any amount.



DO NOT use impact drivers to tighten any fasteners on the Sol-Ark.



MUST use conduit (or double insulated wire) for AC wires entering/exiting Sol-Ark user area.



ALL terminals/breakers, including battery, MPPT, and AC Terminal Block inputs, should only have one conductor connected to them.

1. Sol-Ark: At a First Glance

INSPECT SHIPMENT

The box should include all items shown in the component guide. If there is damage or missing parts, immediately call the phone number (USA) +1 (972) 575-8875 Ext. 2.

COMPONENT GUIDE

The Sol-Ark 15K-2P-N system includes the following components:

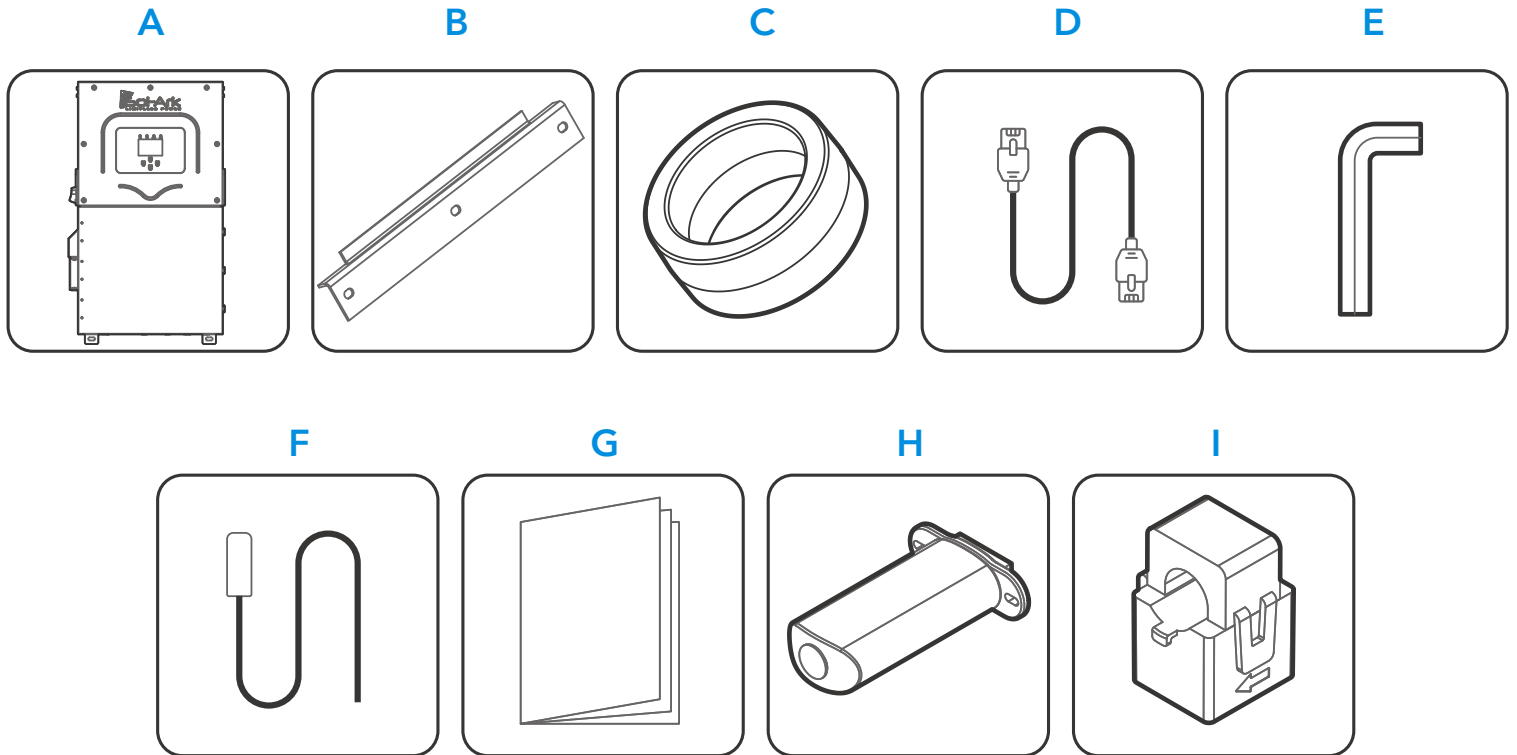

Component	Description	Quantity
A	Sol-Ark 15K-2P-N inverter	1
B	French cleat	1
C	Battery toroid	2
D	CAT 5E communication cable	1
E	Allen key (4 mm)	1
F	Temperature sensor	1
G	User manual	1
H	Wi-Fi / Ethernet antenna (dongle)	1
I	300A (Ø1.378") Current transformers (CT sensors)	2

1.1 General Description

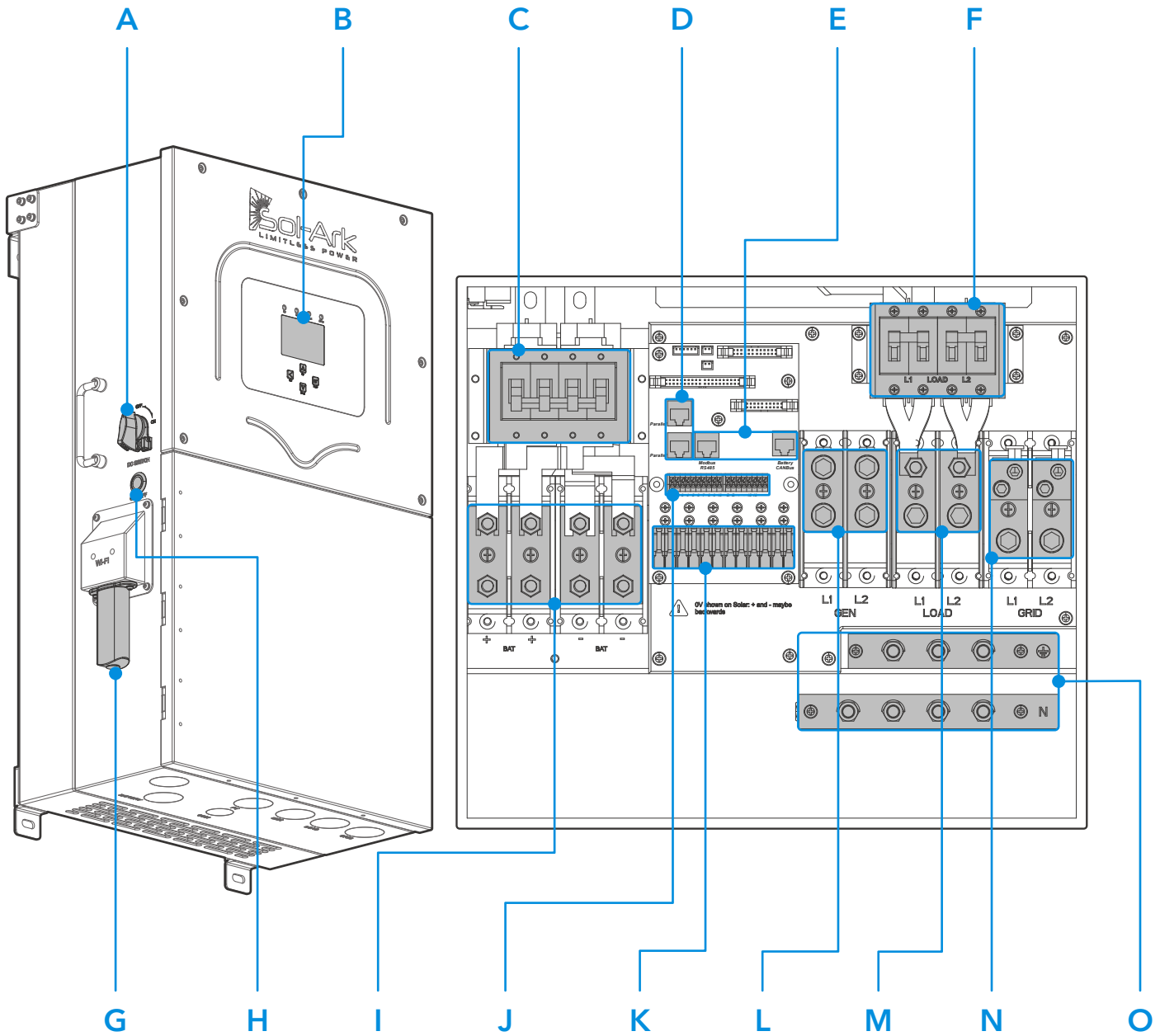

Component	Name	Component	Name
A	PV DC disconnect	I	Battery terminals
B	LCD touch screen	J	Input pinouts for sensors and accessories
C	2x (200A) battery breakers	K	3x MPPT inputs
D	Parallel RJ45 ports	L	(90A) GEN terminal
E	BMS RJ45 ports (RS485 / CAN)	M	(200A) LOAD terminal
F	(200A) LOAD breaker	N	(200A) GRID terminal
G	Wi-Fi / Ethernet dongle	O	GROUND / NEUTRAL Busbars
H	ON / OFF Button		

1.2 Specifications

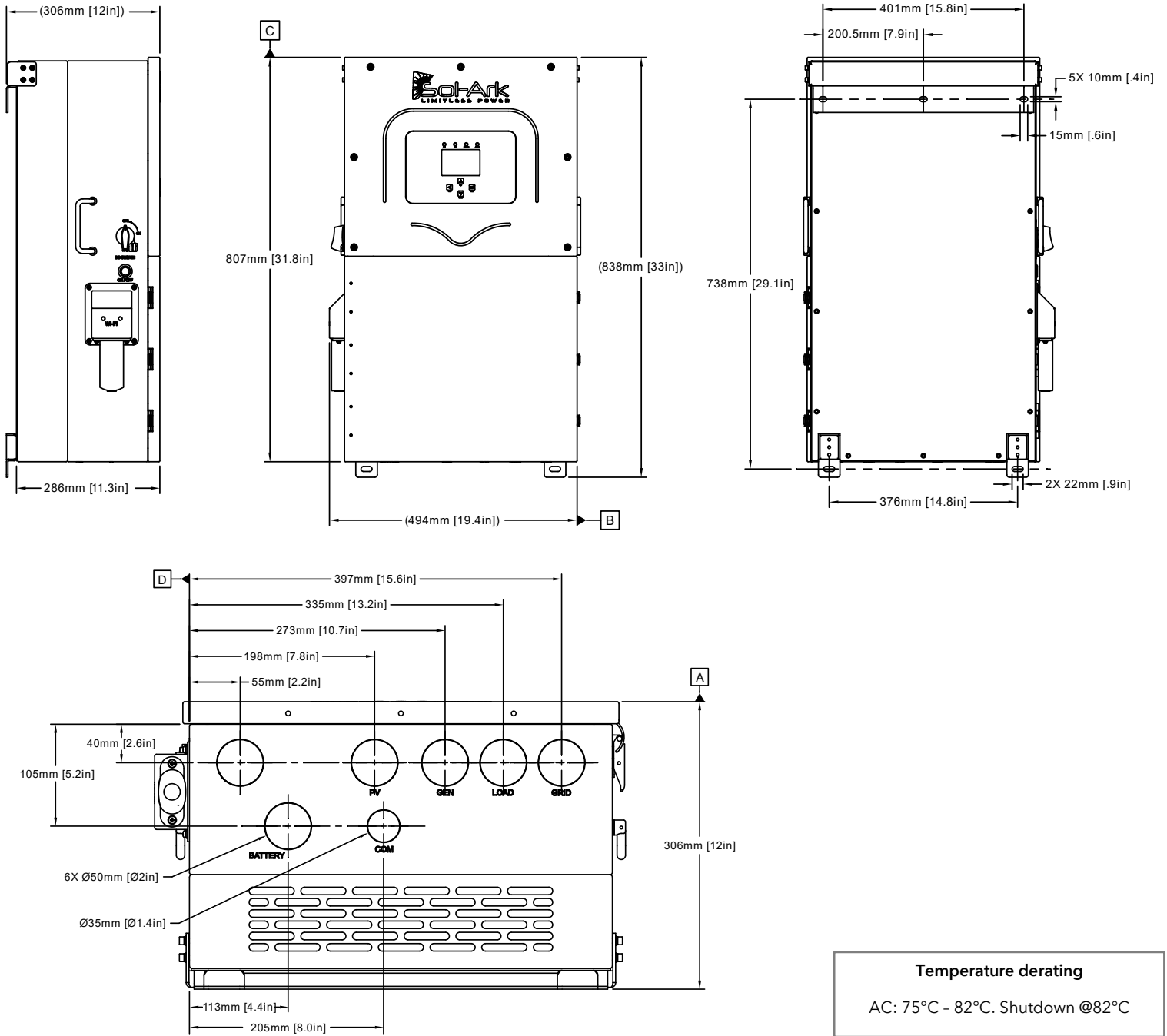

Temperature derating
 AC: 75°C - 82°C. Shutdown @82°C

SOL-ARK 15K-2P-N TORQUE VALUES APPLICATION NOTE

Do not use impact drivers to tighten any fasteners on the Sol-Ark

Terminal / Breaker	Torque [in-lb]	Torque [Nm]
"LOAD"	165 in-lb	18.6 Nm
"GRID"	165 in-lb	18.6 Nm
"GEN"	165 in-lb	18.6 Nm
Neutral / Ground (Busbar)	121 in-lb	13.7 Nm
Cover Screws	15.5 in-lb	1.75 Nm
Battery Connection	90 in-lb	10 Nm

DATASHEET

15K-2P-N

Residential Hybrid Inverter

Inverter Model:

Limitless 15K-LV

SKU: 15K-2P

Input Data (PV)	
Max. Allowed PV Power (STC)	19,500W
Rated MPPT Operating Voltage Range	175 - 425V
MPPT Voltage Range	150 - 500V
Startup Voltage	125V
Max. DC Input Voltage ¹	500V
Max. Operating Input Current per MPPT	26A
Max. Short Circuit Current per MPPT	44A
No. of MPP Trackers	3
No. of PV Strings per MPPT	2
Max. AC Coupled Input	19,200W
Output Data (AC)	
Nominal AC Voltage	120/240V, 120/208V, 220V
Grid Frequency	50 / 60Hz
Real Power, max continuous	15,000W
Max. Output Current	62.5A
Real Power, max continuous (batteries only, no PV)	12,000W (50A @ 240V)
Peak Apparent Power (10s, off-grid)	24,000VA @ 240V
Peak Apparent Power (100ms, off-grid)	30,000VA @ 240V
Max Output Fault Current (5s)	94A with PV, 75A (batteries only)
Max Output Fault Current (100ms)	120A
Max. Grid Passthrough Current	200A
Power Factor Output Range	+/- 0.9 adjustable
Backup Transfer Time	5ms
CEC Efficiency	96.5%
Max Efficiency	97.5%
Design (DC to AC)	Transformerless DC
Stackable	Up to 12 in parallel
Battery Input Data (DC)	
Battery Technologies	Lithium / Lead Acid
Nominal DC Voltage	48V
Operating Voltage Range	43 - 63V
Capacity	50 – 9900Ah
Max. Battery Charge / Discharge Current	275A
Battery Disconnecting Means	200A/pole x 2
Charging Controller	3-Stage with Equalization
Grid to Battery Charging Efficiency	96.0%
External Battery Temperature Sensor (BTS)	Included
Automatic Generator Start (AGS)	2 Wire Start - Integrated
BMS Communication	CANBus & RS485 MODBUS
General Data	
Dimensions (H x W x D)	807 x 494 x 306 mm (31.8 x 19.4 x 12 in)
Weight	61.2 Kg / 135 lb.
Enclosure	IP65 / NEMA 3R
Ambient Temperature	-25~55°C, > 45°C Derating
Noise	< 30 dB @ 25°C (77°F)
Idle Consumption - No Load	90W
Communication and Monitoring	Wi-Fi & LAN Hardware Included
Standard Warranty	10 Years
Protection and Certifications	
Certifications and Listings	UL1741-2010/2018, IEEE1547a 2003/2014, FCC 15 Class B, UL1741SB, CA Rule 21, HECO Rule 14H
PV DC Disconnect Switch – NEC 240.15	Integrated
Ground Fault Detection – NEC 690.5	Integrated
PV Rapid Shutdown Control – NEC 690.12	Integrated
PV Arc Fault Detection – NEC 690.11	Integrated
PV Input Lightning Protection	Integrated
PV String Input Reverse Polarity Protection	Integrated
AC Output Breaker - 200A	Integrated
Surge Protection	DC Type II / AC Type II

1. See Installation Guide for more details on sizing array strings. The highest input voltage is based on the open-circuit voltage of the array at the minimum design temperature.

1.3 Connection Requirements

1. AC / DC Connection Requirements

⚠️ All wire runs should be sized to be at or below a 2.5% voltage drop at full load. Wire size must comply with your local electrical code.

Port	Terminal Rating	Terminal Wire Size Range (min-max)
GRID	200A _{AC}	1/0 - 4/0 AWG
LOAD	200A _{AC}	1/0 - 4/0 AWG
GEN	90A _{AC}	2 - 4/0 AWG
MPPT	44A _{ISC}	12 - 10 AWG
Battery Port A	200A _{DC}	2/0 - 4/0 AWG
Battery Port B	200A _{DC}	2/0 - 4/0 AWG

2. Sensors and Communications Requirements

Component	Wire Size Range	Max Distance
CT Sensor	16-20 AWG	0' - 10' [3 m]: 16 AWG included 10' - 20' [6 m]: CAT6 extendable
Communications	24 - 23 AWG	0' - 100' [30 m]: 24 AWG 100' - 400' [120 m]: 23 AWG
RJ45 Parallel Communication	CAT 5E or better	0' - 7' [2.1 m]: Included 7' - 20' [6m]: Extendable

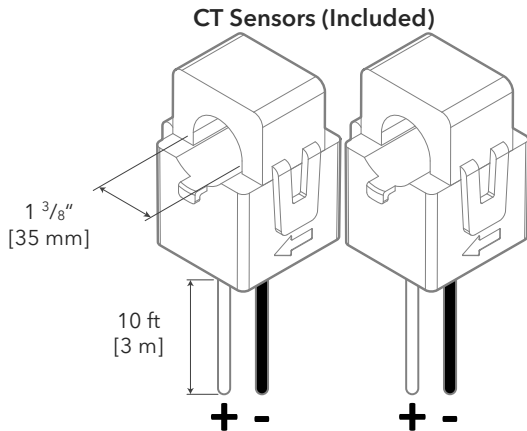
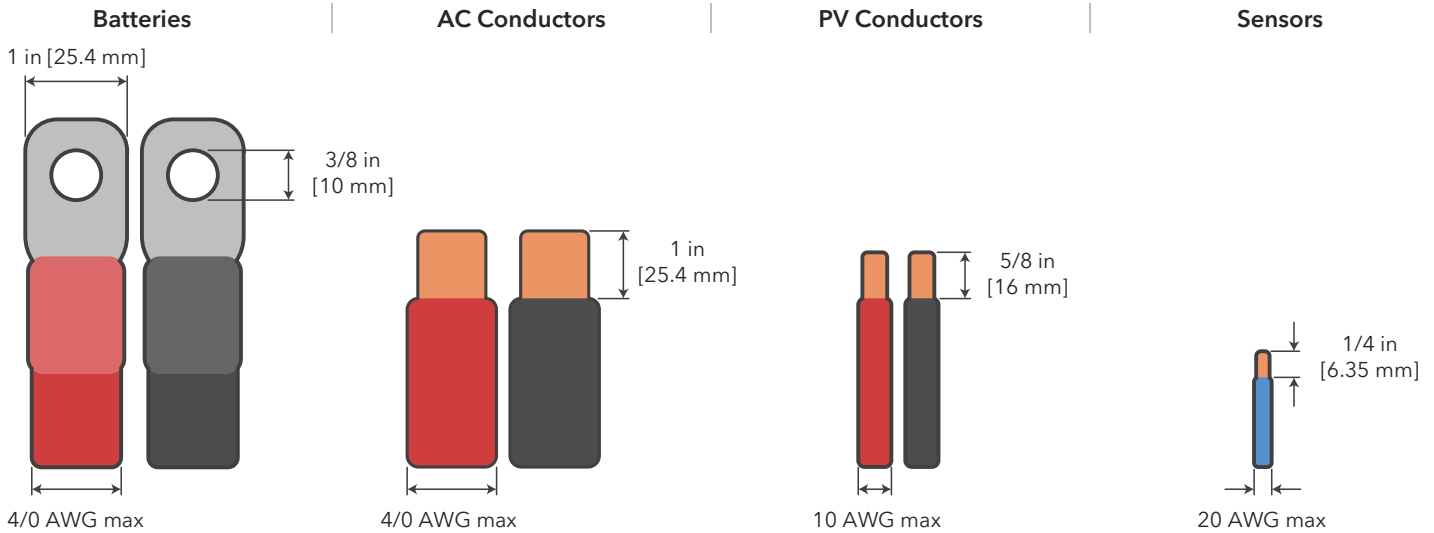

2. Installation

Backup Circuits

- A. The "LOAD" connected service panel will be referred to as the **Essential Loads Panel**.
- B. You must keep the essential loads panel within the limitations of the unit:
 - Grid Tie → 48 kW = 240V * 200A max (passthrough).
 - Off-Grid → 15kW = 240V * 62.5A continuous (PV & battery) | 12kW = 240V * 50A continuous (batteries only).
- C. Verify that every load circuit power ($P=V*I$) does not surpass the aforementioned limits.

Single System Install

- A. **FOR PARTIAL BACKUP:** Connect the output of the back-feed breaker or line side tap (depending on the point of interconnection) to the "GRID" terminal.
 - An external disconnect must be installed between the interconnection and the Sol-Ark. Size the disconnect according to code.
 - Connect the "LOAD" output to the Essential Loads Panel. Follow electric code to select proper wire gauge.
- B. **FOR WHOLE-BUSINESS BACKUP:** Connect the utility grid directly to the "GRID" terminal.
 - An external disconnect must be installed between the grid and the Sol-Ark. Size the disconnect according to code.
 - Connect the "LOAD" output to the Main Service Panel. Follow electric code to select proper wire gauge.

It is possible to connect a generator or an AC coupled source (80A max or 19,200W) such as string or micro inverters to the "GEN" terminal of the inverter. Only one AC source can be connected to the "GEN" terminal at a time.

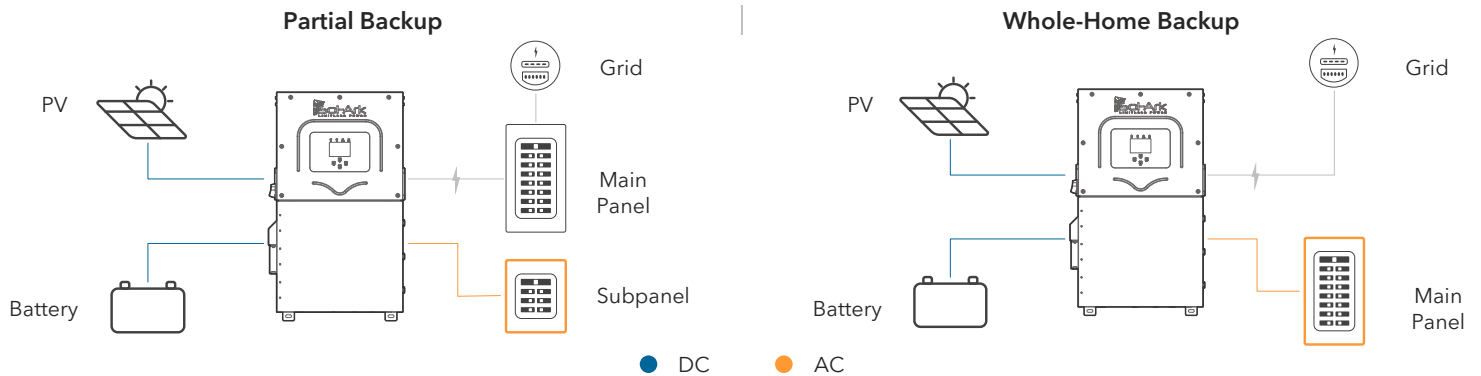

2.1 Mounting the Sol-Ark

- A. Considering the dimensions of the inverter, find a suitable location for the system. There must be at least 6 in [15 cm] of vertical clearance and 2 in [5 cm] of side clearance for proper heat dissipation.

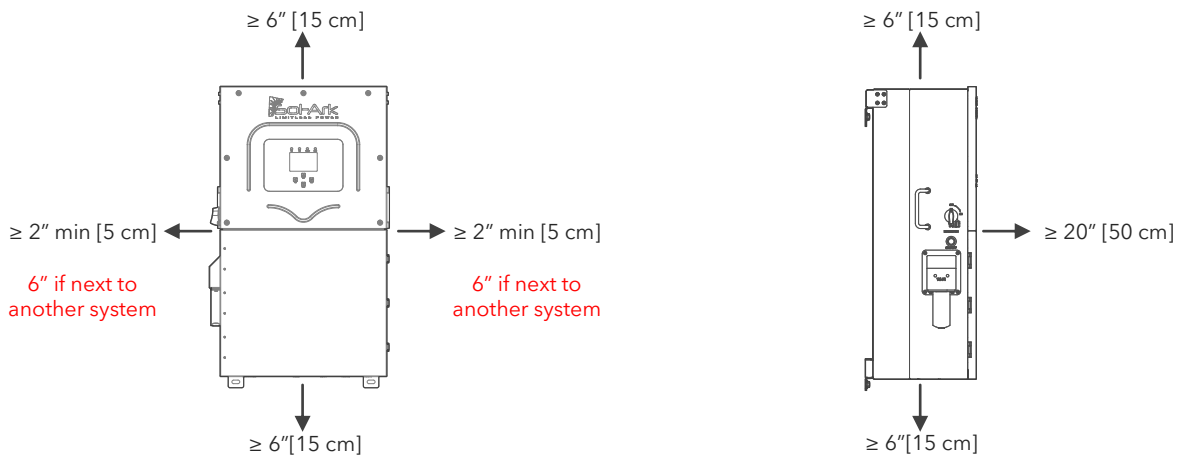

! Max heat dissipation of 525W

- B. Under certain conditions, the National Electrical Code® specifies greater clearances. Ensure that the prescribed clearances in accordance with the National Electrical Code®, paragraph 110.26 and Canadian Electrical Code® CSA C22.1 are adhered to.
- C. The Sol-Ark 15K-2P-N is a NEMA 3R - IP65 enclosure that is rated for outdoor installation but can also be installed indoors.
- D. **⚠️ PROTECT THE LCD SCREEN** from direct exposure to UV light.
- E. Use screws or anchors suitable for the support surface and capable of supporting the weight of the inverter (135 lb / 61kg).
 - a. For Concrete or Masonry Mounting: Use a minimum of five (5) 3/8in expanding anchors (not included).
 - b. For Wood Frame Mounting: Use a minimum of five (5) 3/8in lag screws with flat washers, making sure to anchor into at least 2 framing members. (not included)
 - c. For Metal Framing Mounting: Use a minimum of five (5) 1/4in self-tapping metal screws with flat washers. (not included)
- F. In the case a different anchorage is required, calculate the support needed to properly hold the weight of the equipment.

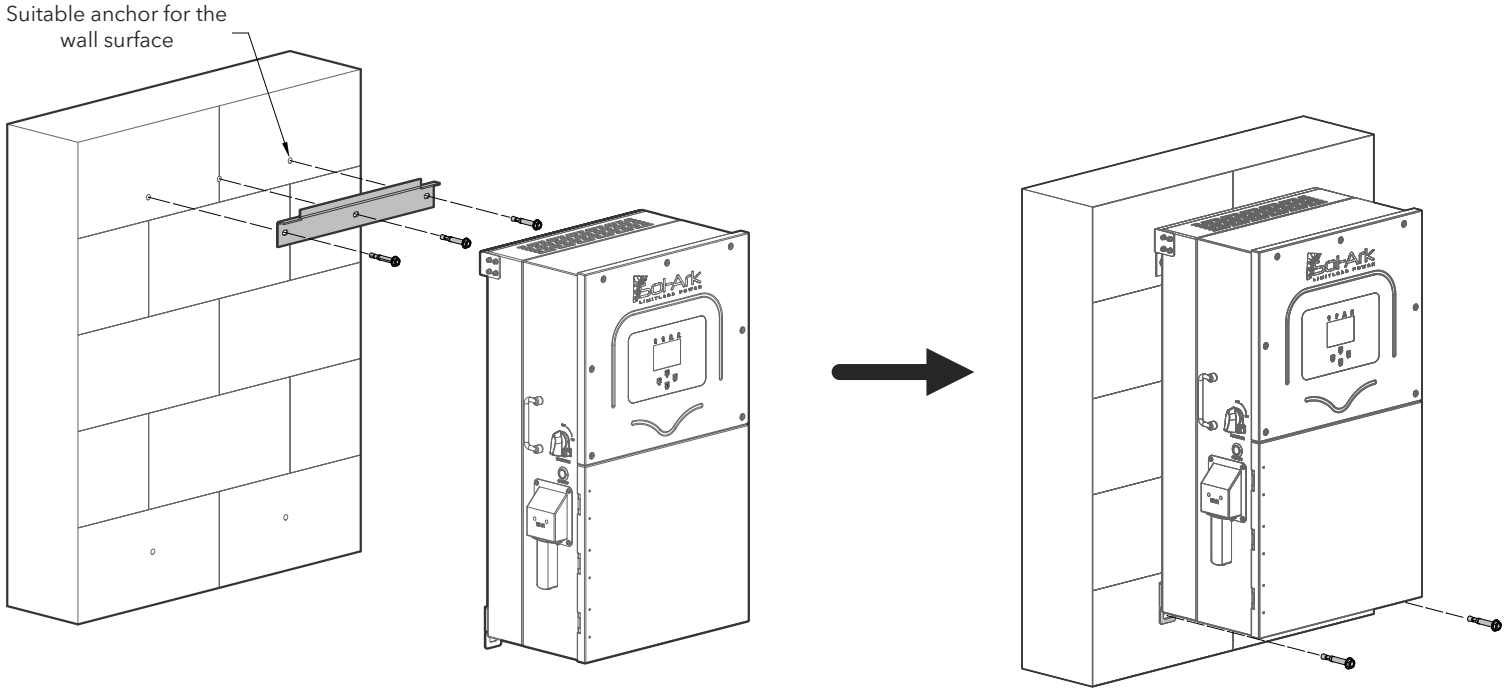

⚠️ *Damage to the LCD Screen due to direct sunlight exposure will not be covered by warranty*

- G. Mount the inverter in the optimal orientation as shown below.

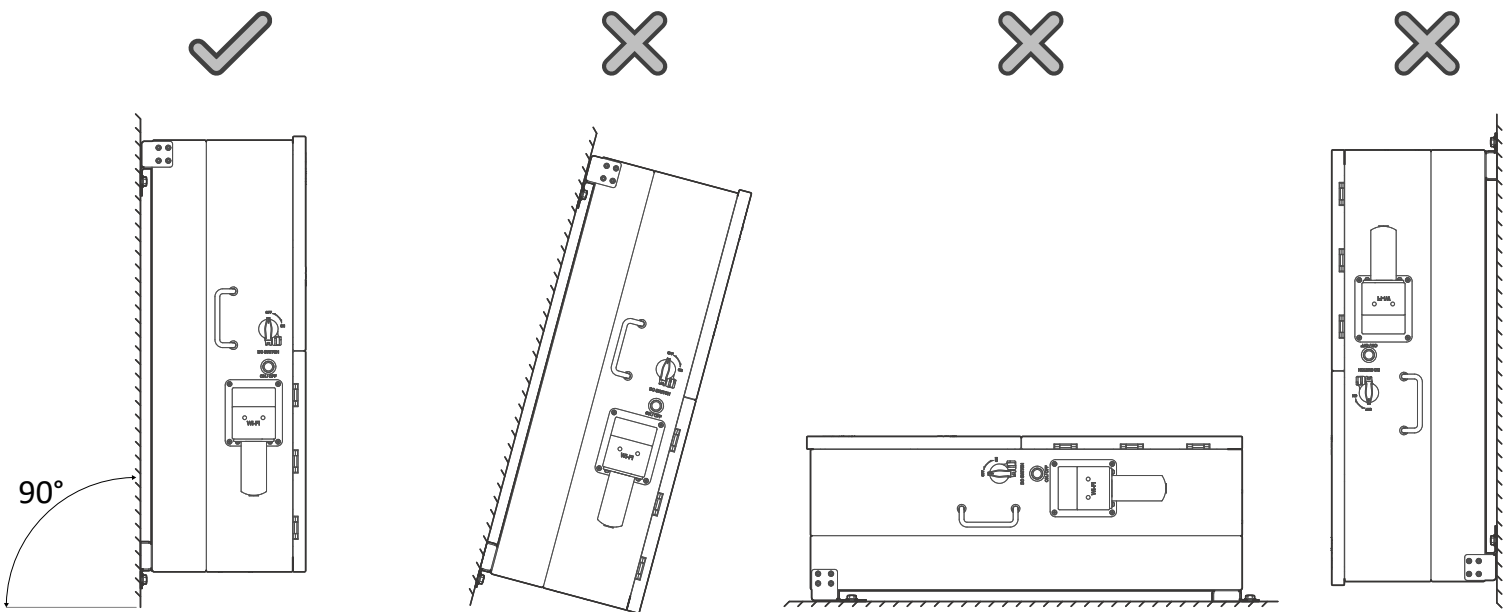

2.2 Integrating Batteries

- A. ⚠ Sol-Ark 15K-2P-N must be OFF while the batteries are being connected.
- B. Depending on the battery voltage, wire up the battery bank in the possible configurations shown below.
- C. Battery breakers must be OFF when wiring. If your battery bank does not have internal breakers, maintain the necessary safety measures when handling.
- D. ⓘ The 15K-2P-N reaches a max battery charge/discharge of 275A if using both sets of battery terminals. If only one set of terminals is used, the max battery charge/discharge will be limited to 160A

⚠ Sol-Ark 15K-2P-N is a **48V_{DC} nominal system**. **DO NOT** connect the inverter to any other battery configuration. If you use 12V batteries, you **MUST NOT** exceed four (4) batteries in series, as shown. The inverter can work with any battery chemistry as long as it remains within the range of **43V_{DC} to 63V_{DC}**.

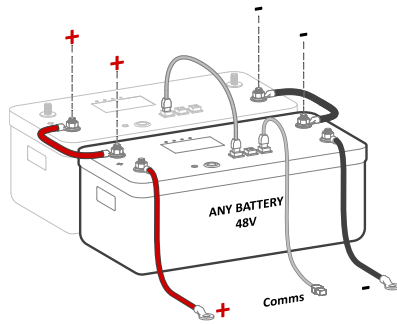

48V batteries in parallel connection

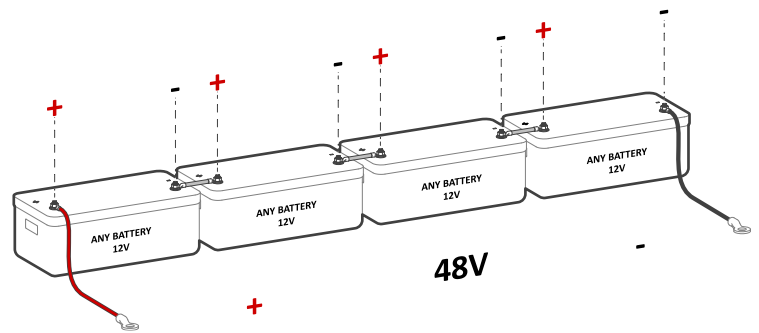

12V batteries in series connection

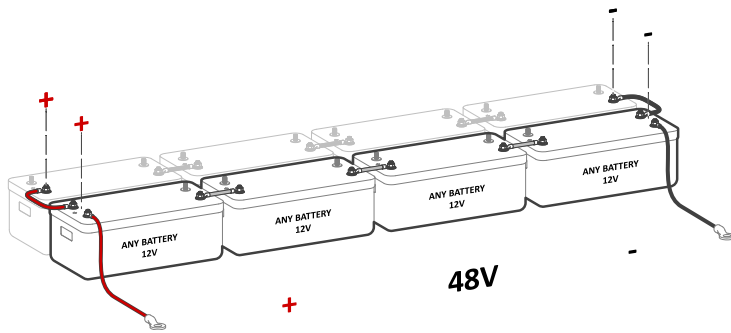

Series and parallel connections for complete 48V batt bank

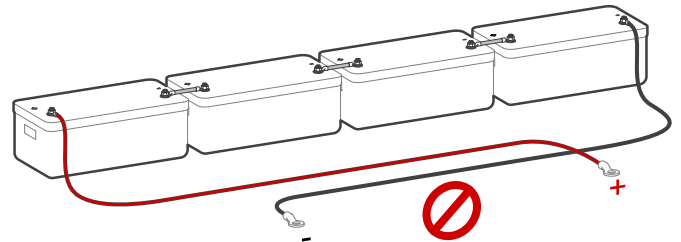

⚠ **DO NOT** reverse polarity. The system will be damaged, and warranty will be voided!

1. Battery Toroid

Install the included toroids on the battery conductors as shown in the next figure. Ensure that both (+) and (-) wires pass through both toroids simultaneously. When there are four (4) wires present, all conductors must go through the toroids as depicted below.

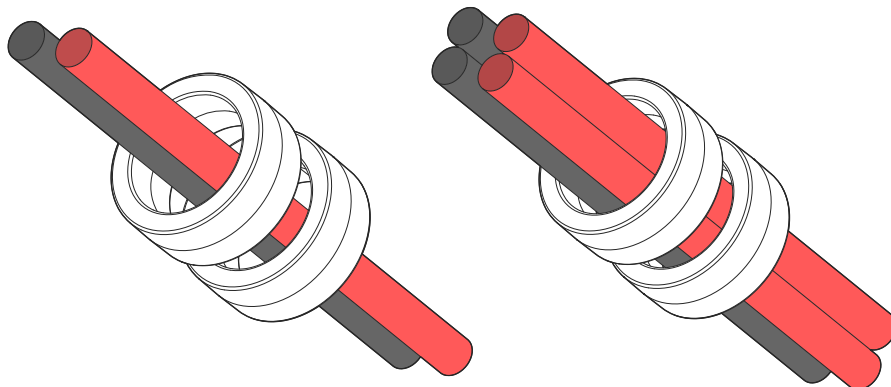

2. Multi-Terminal Installation

The two battery input terminals of the 15K-2P-N will parallel batteries internally to ensure a common connection between battery banks and simplify battery installations. If a charge / discharge rate of 275A is needed, the batteries must be connected to both input terminals. If using 3 or more batteries, use external busbars for (+) and (-) connections.

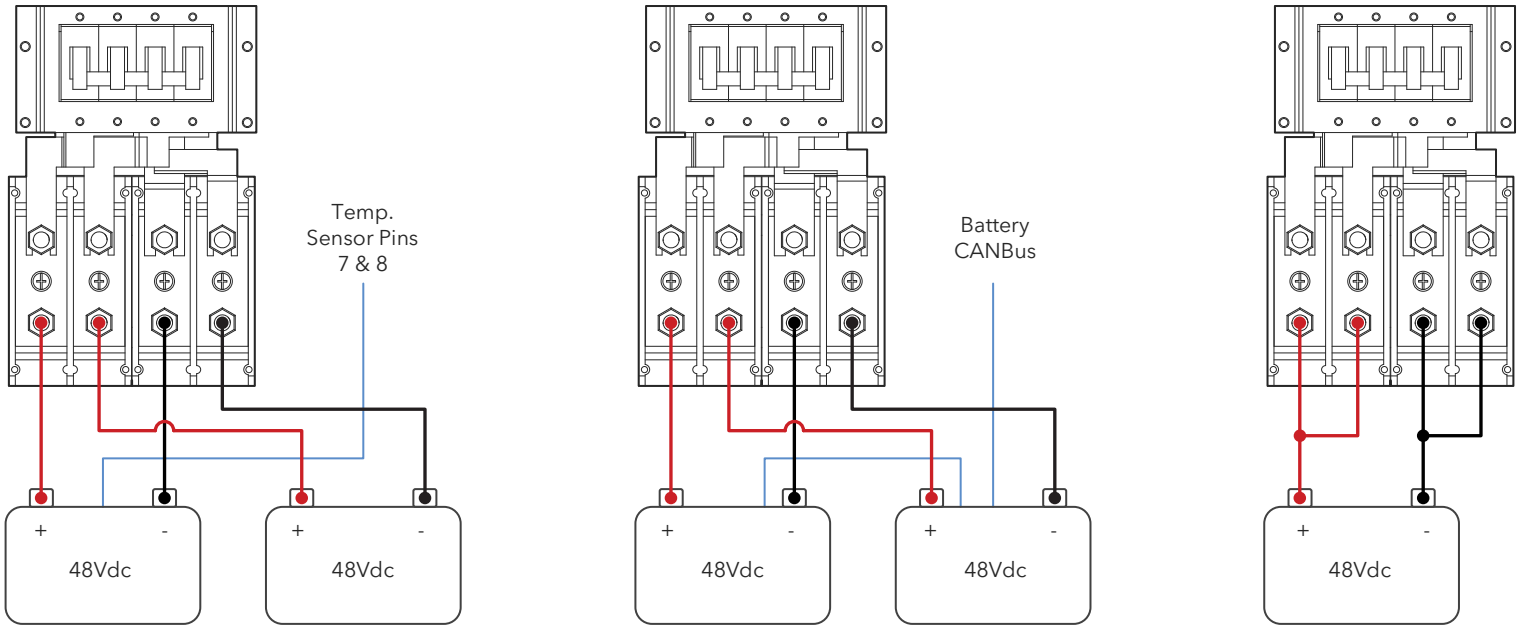

If a single battery is capable of charging / discharging above 160A, connect the battery to both input terminals. Otherwise, the charge and discharge rate will be limited to 160A max. Connect batteries of the same brand, model, and chemistry to both terminals

! IMPORTANT NOTE: Multi-system install

- A. **ALL** parallel inverters **MUST** connect to a single battery bank. The system will **NOT** operate properly if this instruction is not followed.
- B. **DO NOT** use separate battery banks in parallel systems.

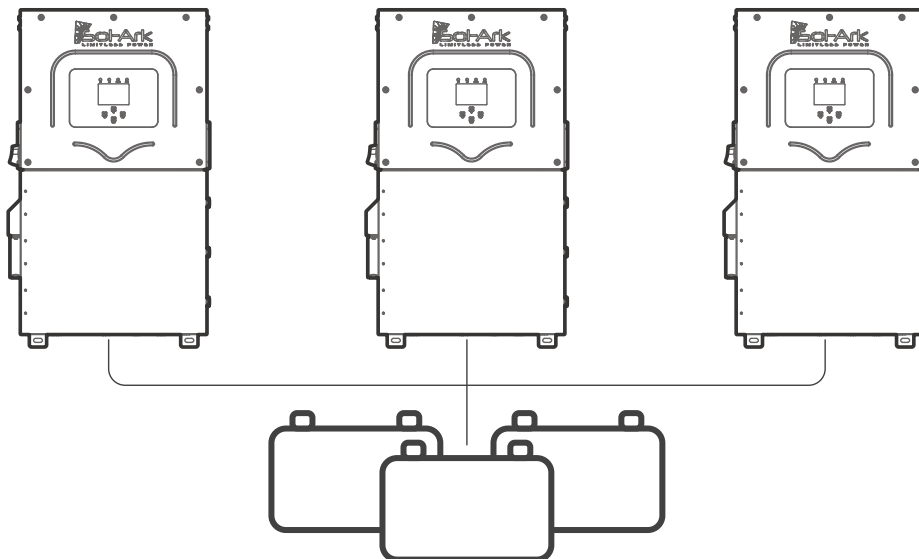



Follow all battery manufacturer-specified values to ensure proper charging and discharging

BATTERY CHARGING SETPOINT EXAMPLES (48V NOMINAL)

Battery Type	Absorption	Float	Equalize (Every 30 days for 3hr)
AGM / PCC	57.6V	53.6V	57.6V
Gel	56.4V	54.0V	
Wet	59.0V	55.0V	59.0V
Lithium	54.6V	54.3V	-

CALCULATING BATTERY BANK AMP-HOURS EXAMPLES (AGM)

# of batteries	Voltage per Battery	Ah per battery	Ah @48V (Chain of 4 batteries of 12V in series)	Max Charge / Discharge (A)
4	12V	230Ah	230Ah	100A
8	12V	230Ah	460Ah	200A
12	12V	230Ah	690Ah	275A
16	12V	230Ah	920Ah	275A

2.3 Battery Communication

RJ-45 Configurations

The Sol-Ark 15K-2P-N inverter achieves battery communications through a single RJ-45 port labeled "Battery CANBus". This port combines the RS-485 and CANBus pin configurations shown below. Both "Modbus RS485" and "Battery CANBus" ports are capable of Modbus communication.

Pin	RS485	Battery CAN Bus
1	RS-485 A+	--
2	RS-485 B-	--
3	--	--
4	--	CAN Hi
5	--	CAN Lo
6	GND	GND
7	RS485 A+	--
8	RS485 B-	--

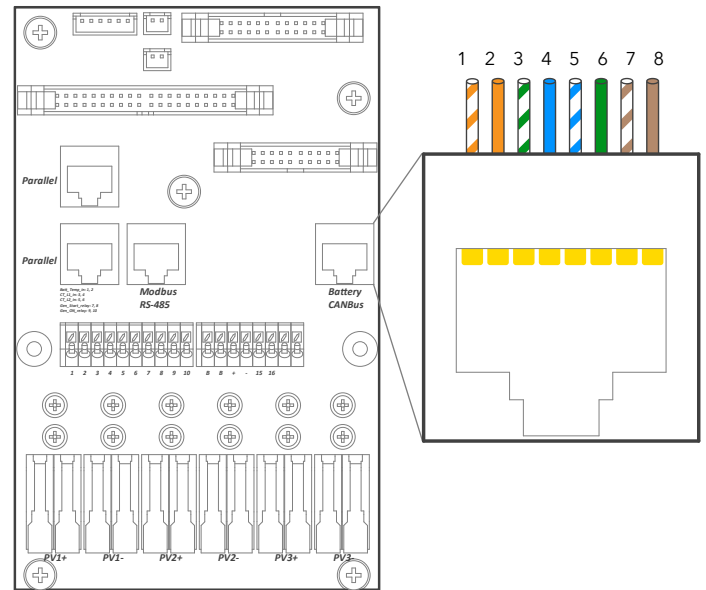

RJ-45 port configuration



Complete battery integration guide of supported battery communications can be found at: sol-ark.com/battery-partners



Any damage caused by the improper use of the communication protocols (CANBUS or MODBUS) will not be covered by warranty. Modbus map is available upon request for "READ" operations only. Contact technical support to obtain the MODBUS map.

External MODBUS Devices

If an external device utilizes **BMS Lithium Batt 00**, one must change the **Modbus SN** of the inverter to **01** as the default value is 00.

2.4 Connecting PV Modules

E.M.P Systems Only - Suppressor Installation

If you purchased your system with Lightning / EMP Hardening, most of the protection is within the Sol-Ark. However, additional EMP suppressors are included to protect home appliances and solar panels. The Sol-Ark 15K-2P-N includes:

- 28 - Small suppressors
- 44 - Big suppressors

Although not critical, suppressor installation is recommended. These suppressors must be installed on the power cord, as close to the appliance as possible. Additionally for solar panels, the big suppressors must clamp both conductors and must be secured with a zip tie. If you purchased the solar panels from us, a $>150\text{kV/m}$ protection has already been installed inside the solar panels.

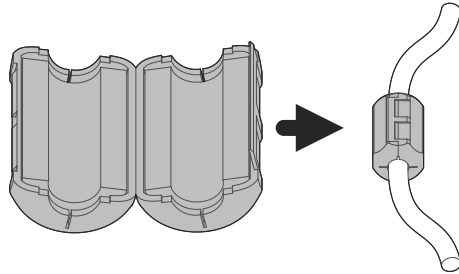

a) Installation of small suppressor on appliance power cord

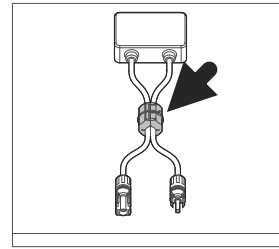

b) If not using panels from Sol-Ark: big suppressor on solar panel

! The Sol-Ark 15K-2P-N has 3 independent MPPTs that support up to 2 PV strings each. MPPTs can handle a maximum **Voc of 500V** and an **Isc of 44A** but will self-limit and operate at **26A max**.

- A. Max DC solar input = 19.5 kW ($\pm 5\%$) | Max input power per MPPT = 6.5 kW | Max recommended input voltage per MPPT = 425 Voc | Max input current per MPPT = 26A (self-limiting).
- B. **!** Design for a max input current of 26A per MPPT. The inverter will self-limit beyond 26A. If Isc exceeds 44A, damage will occur.
- C. **!** **PV Source Circuit max voltage of 500V_{DC}; damage can occur with PV strings whose open-circuit voltage exceeds 500V_{DC}**
- D. **!** Strings in parallel on the same MPPT must have the same designed open-circuit voltage (Voc), otherwise the system will be limited to the lowest string voltage.
 - i. PV1 A/B must have the same Voc.
 - ii. If the solar panels are oriented in different directions and connected in the same MPPT, there will be a loss in PV efficiency.
- E. **!** Per NEC Art 690.43, exposed non-current-carrying metal parts of PV module frames, electrical equipment, and conductor enclosures of PV systems shall be connected to an equipment grounding conductor. All grounding conductors and grounding electrodes should be installed according to NEC Art 690.47 or as required by the AHJ.
- F. For ground mounted arrays, Sol-Ark recommends installing an auxiliary grounding electrode placed near the array to ensure optimal earth-to-ground resistance of the grounding system. This auxiliary electrode would need to follow the requirements of NEC Art 250.54.
- G. Connect the solar panel strings using either of the following configurations:

"Y" connection

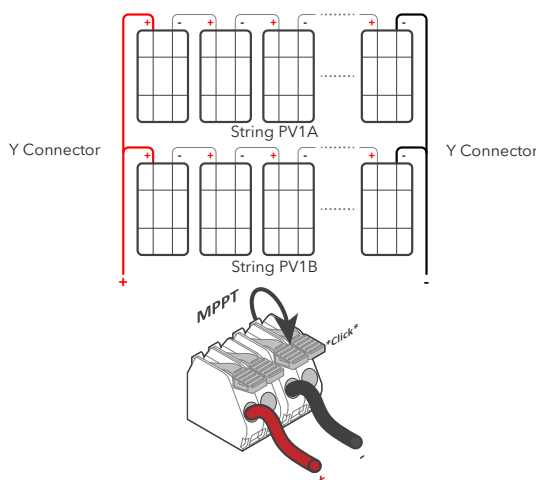

Individual strings

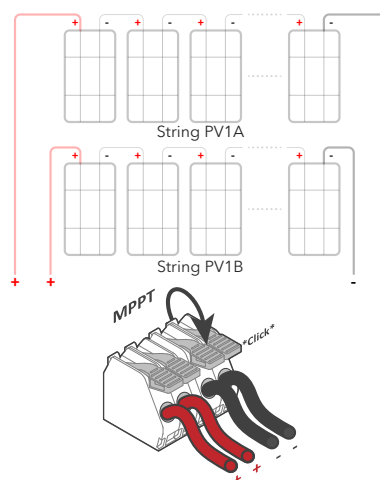

AC Coupling

The Sol-Ark 15K-2P-N is a system that supports the addition of AC coupled solar panels. The max solar input power can be expanded by coupling micro or string inverters into the "GEN" or "LOAD" terminals. A full AC coupled solar system is not recommended as power control and monitoring is limited. Having DC coupled modules or a combination of DC coupled and AC coupled solar panels is always preferred.

AC coupled inverters need to be either UL 1741SA or UL 1741 certified. This certification confirms the inverters' ability to disconnect from the grid based on frequency and ensures that the Sol-Ark will safely be able to frequency shift to control the AC coupled production.

ⓘ Batteries are **REQUIRED** to AC couple solar panels to the "GEN" terminal. The AC coupled inverters can still produce solar power even during grid outage events or in Off-Grid systems. Furthermore, the total AC coupling production will be monitored.

Maximum allowed AC coupling input: 19,200W	Maximum combined solar input (DC + AC): 38,700W
Optimal: 19,500W_{DC} + 19,200W_{AC}	
1. AC coupling on "GEN" <ul style="list-style-type: none">- CAN produce solar power during grid outages.- CAN produce solar power for Off-Grid systems.- CAN monitor solar production.	2. AC coupling on "LOAD" <ul style="list-style-type: none">- CAN produce solar power during grid outages.- CAN produce solar power for Off-Grid systems.- CANNOT monitor solar production.- ⚠ "GEN" input CANNOT be used.- ⓘ Backup Transfer Time is extended to 2 seconds.

ⓘ In Off-Grid systems, Sol-Ark uses **Frequency Shift** technology to shut down AC coupled solutions when the battery is full. Grid-Tied AC coupled solutions will **always** sell excess solar power back to the grid. "Limited to Load" will **NOT** limit production when AC coupled.

2.5 Integrating a Generator

Generators Smaller than 19.2kW → On "GEN" Input

1. **ONLY** Supports 120/240V Split-Phase generators.
2. 90A rated "GEN" terminal. ⓘ 80A continuous.
3. A THD (Total Harmonic Distortion) of less than 15% is preferred.

Generators Greater than 19.2kW → On "GRID" Input

1. Supports 220V Single phase, 120/240V Split phase, 120/208V 3-Phase (2 of 3 phases). The correct grid type must be selected before connecting the generator.
2. ⓘ Programming "**GEN Connect to Grid Input**" is required: ⚙ → *Limiters* → *Other* → **GEN Connect to Grid Input**
3. ⚠ **DO NOT** use "**Grid Sell**" in Off-Grid systems. Potential to damage the generator. Installation of CT sensors on generator lines is only required if "**Peak Shaving**" is intended to be used.

ⓘ **Weekly Gen Exercise:** If a generator has two-wire start compatibility, it will experience weekly generator tests. This test occurs at 8:00AM (local time) every Monday by default. The test takes 20 minutes to complete. The generator will start and stop automatically. The test can be disabled by specifying :00 | 00 min in the "Generator Exercise Cycle Day & Time" option.

Improve the Generator & Sol-Ark Compatibility

Navigate through the menus and program the following settings to improve the Sol-Ark and generator compatibility and operating range to avoid frequent disconnections.

1. Change the grid mode to General Standard: ⚙ → *Grid Setup* → *Grid Selection* → *Grid Mode*.
 - a. Tap and use the navigation arrows to cycle through the different grid modes. Choose "**General Standard**".
2. Increase the frequency range of operation: ⚙ → *Grid Setup* → *Connect* → *Reconnect*
 - a. Increase "**Grid Hz High**" to **65Hz**.
 - b. Decrease "**Grid Hz Low**" to **55Hz**.
 - c. Replicate changes for the "Normal Connect" settings.

3. Increase the voltage range of operation:
 - a. Increase **"Grid Volt High"** to 275V.
 - b. Decrease **"Grid Volt Low"** to 185V.
 - c. Replicate changes for the "Normal Connect" settings.

! Sol-Ark will not charge the batteries using the generator unless the "Start V" or "Start %" condition is fulfilled. Only one condition (V or %) can be modified at a time depending on the control mode selected ("Use Batt V Charged" or "Use Batt % Charged")

2.6 Grid Peak Shaving

1. **!** To use Peak-Shaving on a generator, the equipment **MUST** be connected to the "GRID" terminal of the inverter.
2. Peak-Shaving helps reduce grid consumption during peak demand by utilizing battery backup power. It can also be used to prevent generator overload above a specified power threshold.
3. Install the CT sensors on grid / generator lines L1, L2. The arrows on the CTs **MUST** point toward the grid / generator.
4. The Sol-Ark supplies power from the batteries whenever the **"Power"** threshold is met.
5. This mode will automatically adjust the "Grid Charge" amperage (**A**) to avoid generator overloads during battery charging.
6. **!** Grid Peak-Shaving will automatically enable "Time of Use" and **MUST** be configured.

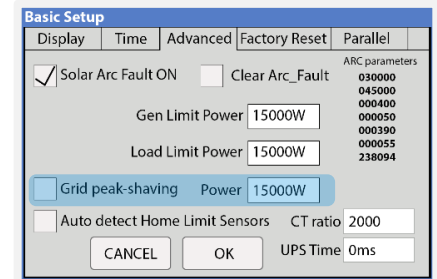

Grid peak-shaving setting

2.7 Automatic Generator Start

1. **Gen Charge** is used when the generator is connected to the "GEN" terminal.
 - a. **"Start V" or "Start %"** is the set-point/condition that must be fulfilled to automatically start the generator.
 - b. To charge from the "GEN" source, Gen Charge must be enabled.
 - c. **!** Batteries will charge from a generator until the battery bank accepts 5% of its programmed capacity in Amperes (A). This is equivalent to around 95% of the state of charge (SOC).
2. **Grid Charge** is used to charge the battery from the "GRID" source (grid or a generator).
 - a. **"Start V" or "Start %"** is the set-point/condition that must be fulfilled to start the battery charge from the "GRID" source. This will auto-start a generator as well.
 - b. To charge the battery from the "GRID" source, Grid Charge must be selected: ⚙️ → Battery Setup → Charge.
 - c. **!** From utility grid: the batteries will be charged to 100% SOC.
 - d. **!** From generator: the batteries will charge until the battery bank accepts 5% of its rated capacity in Amperes (A). This is equivalent to around 95% SOC.

! If "Time of Use" (TOU) is enabled, a time to charge from that GRID or GEN source **MUST** be designated. Charge must be checked on desired time intervals, otherwise the generator will not start automatically even if the Start V or Start % condition has been met.

Gen Charge / Grid Charge "A"

"A" is how many amps (DC) are supplied to the battery from a generator. Adjusting and limiting the GEN or GRID "A" value will ensure that small generators are not overloaded when charging the battery bank.

If connecting more than one Sol-Ark in parallel, multiply the Gen or Grid "A" value by the # of Sol-Ark inverters to get the actual current (A) what will go into the battery bank.

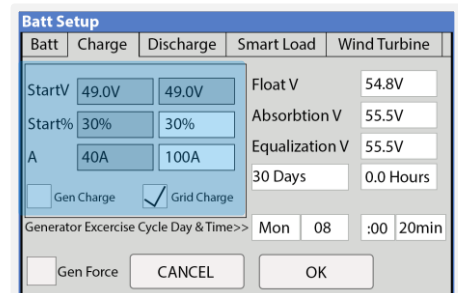

Generator and grid charge settings

2.8 Integrating Sensors and Accessories

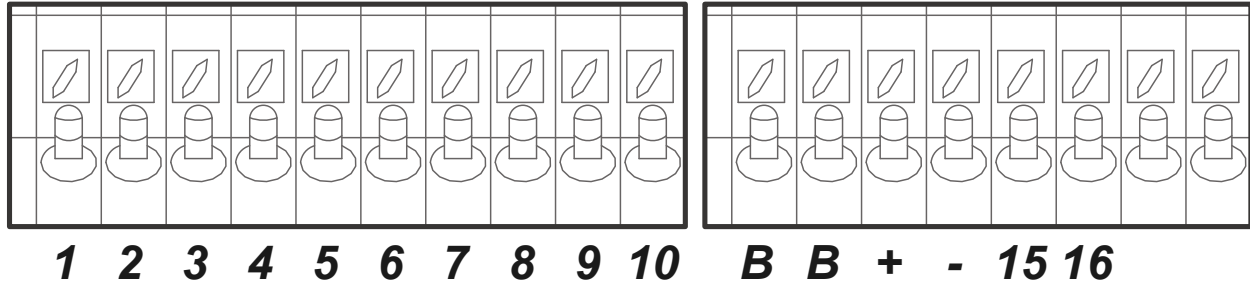

Inverter pinouts for sensors and accessories

- (1,2) **Battery temperature sensor:** Not polarity sensitive. Used for voltage compensation for Lead Acid batteries
- (+3, -4) CT1 & (+5, -6) CT2: Current transformer (CT) inputs
- (7,8) **Gen Start Relay:** Normally open relay for generator two-wire start (⚠️ 12V, 100mA max)
- (9,10): Not in use
- (B, B) **Emergency Stop:** Normally open dry contact for emergency stop
- (+, -): Not in use
- (+15, -16): 12Vdc (-3%) power supply for RSD transmitters (100mA max, 12V_{DC}, 1.2W)

1. Temperature Sensor

- Place the sensor between two batteries as shown in the next figure.
- Secure with tape and place away from the batteries terminals to prevent overheating.
- This sensor has no polarity. The temperature sensor helps perform voltage charging adjustments and capacity calculations due to changes in temperature.
- **!** Lithium Batteries **DO NOT** require our external temperature sensor.

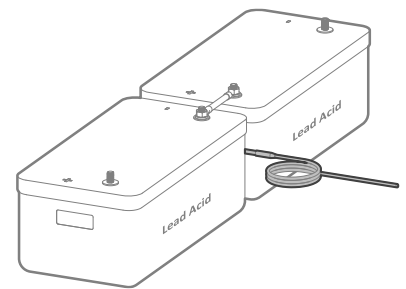

Temperature sensor

2. Wi-Fi / Ethernet Antenna (Dongle)

- Remote monitoring and software updates require an internet connection through the Wi-Fi / Ethernet Antenna (Dongle).
- Compatible with Wi-Fi or Ethernet connections.

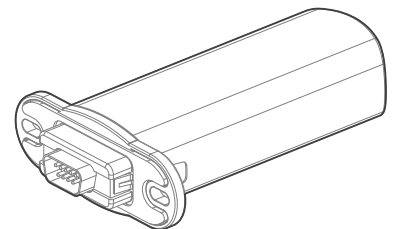

Wi-Fi dongle (antenna)

3. BMS Port (CAN/RS485)

- This port is used to setup a Lithium Battery in closed-loop communication with the Sol-Ark 15K-2P-N (consult our **"Battery Communications Integration Guide"** on the Sol-Ark website at www.sol-ark.com/battery-partners).
- Must use an RJ45 connector.
- Only use the CAN port for battery BMS communications (the CAN port supports both CANBus protocol and Modbus protocols).

4. GEN Start Signal (Two-wire start)

- Gen start relay: pins 7 & 8.
- The signal comes from a normally open relay that closes when the generator **"Start"** condition is met

2.9 Limit Sensors (CT sensors)

The CT sensors (or limit sensors) enhance system capabilities by enabling the use of the system work modes known as **"Limited Power to Home"** (Meter Zero) and **"Grid Peak-Shaving"**. The CTs will measure and calculate total load demand which the Sol-Ark 15K-2P-N will then use to accurately supply and offset all existing loads (Meter Zero).

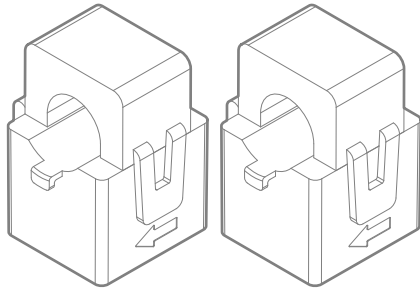

! Off-Grid system do not require CT sensors unless "Grid Peak-Shaving" is used

1. CT Sensors Installation

- Install sensors on incoming electrical service wires (L1, L2, and L3 if the system is 3 Φ).
- Embossed arrows on the sensors must point towards the grid.
- ! If the system is 3 Φ , the arrows must point towards the inverter(s).
- To ensure proper fit, check incoming wire diameters (grid or generator). If the sensors are too small, bigger CTs can be purchased by calling sales: +1-972-575-8875 ext. 1 or sales@sol-ark.com
- **"Limited Power to Home"** (Meter Zero) and **"Grid Peak Shaving"** require CT sensors.
- See section 3.5 "Limiter" for more information about the different work modes.
- See section 7 "Wiring diagrams" for more information on CT installation.

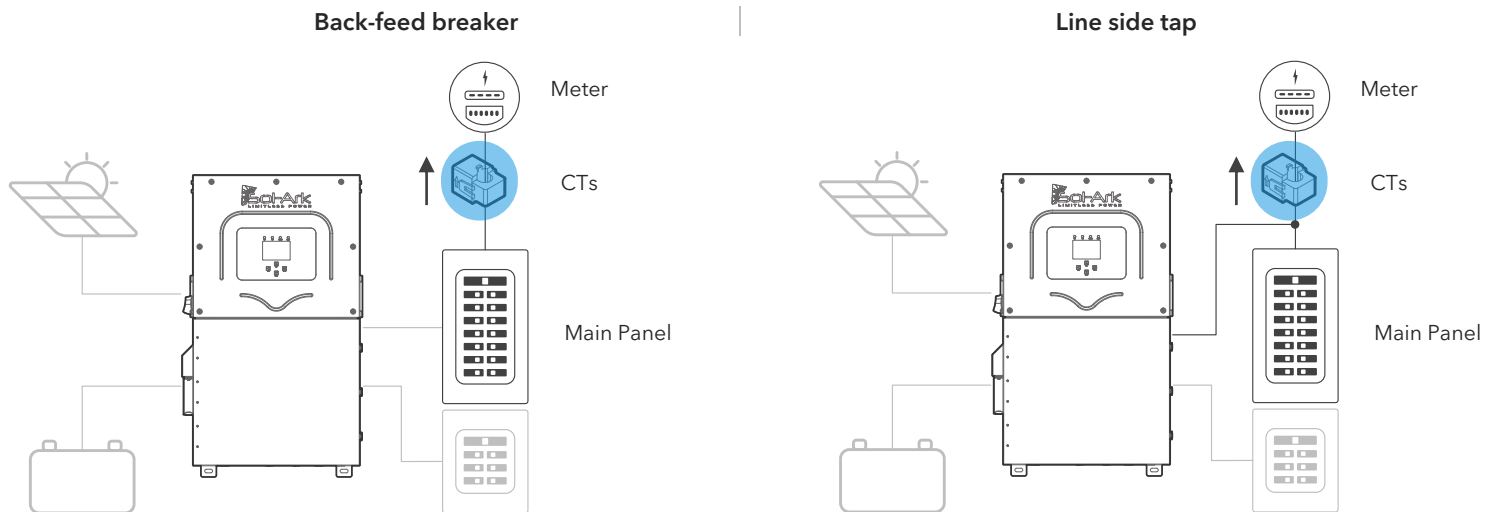

2. CT Sensor Size

- The Sol-Ark 15K-2P-N includes two **300A** CT sensors ($\varnothing 1.378"$).
- Sol-Ark offers large **200A** ($\varnothing 0.945"$) and extra-large **600A** ($\varnothing 1.976"$) CT sensors upon request. Visit <https://shop.sol-ark.com/> or contact sales at +1 (972) 575-8875 / sales@sol-ark.com to purchase bigger CT sensors.
- Default Sol-Ark CT ratio is 2000:1

! Unless authorized, **DO NOT** change CT Ratio or warranty will be voided

3. Wiring the CT sensor

- Connect CT1 of line L1 to pins 3 (white) & 4 (black).
- Connect CT2 of line L2 to pins 5 (white) & 6 (black).
- Keep the wires twisted (white-black) throughout the connection.
- If the wires need to be extended, use CAT 6 (shielded) cable to make an extension.

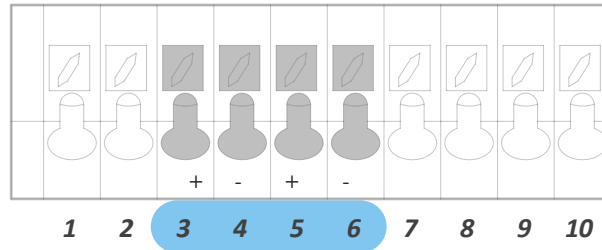

CT Sensors for 120V/240V Split Phase

- Each inverter will include two (2) CT sensors.
- Only one pair of CT sensors must be wired to the designated "Master" inverter.
- **!** CT sensors are essential for multi-Sol-Ark systems as "Limited Power to Home" mode is highly recommended.

CT Sensors for 120V/208V Three-Phase

- Install CT1 on L1 and CT2 on L2 of inverter 1. Program inverter 1 to Master, Phase A.
- Install CT3 on L3 of inverter 2. Program inverter to be Master Phase B.
- **!** CT sensors on 3-Phase systems **MUST point in the opposite direction** (i.e., towards the inverters).

4. Automatic CT Limit Sensors Configuration

This function **REQUIRES** batteries and 120/240V grid to auto detect and auto correct CT orientation. AC coupled inverters need to be **OFF** during the detection test. If this test is done with connected AC-coupled systems, a factory reset of the Sol-Ark must be performed. Install the CT sensor as described in section 2.9 "Limit Sensors". A battery connection and grid power are required before starting the automatic configuration.

⚙️ → Basic Setup → Advanced → Auto detect Home Limit Sensors

Wait at least 10 to 15 seconds while the inverter performs the test. The inverter will alternate the current distribution in all lines, determining the correct orientation of the sensor.

- **!** On "Limited power to Home" mode (no Grid Sell), HM values will read close to zero (0). Keep in mind that all sensors have a 3% error.
- To avoid selling power to the utility use "Zero Export Power" equal to or greater than 20W.
- Buying power from the grid will display positive (+) HM values, while selling to the grid displays negative (-) HM values.

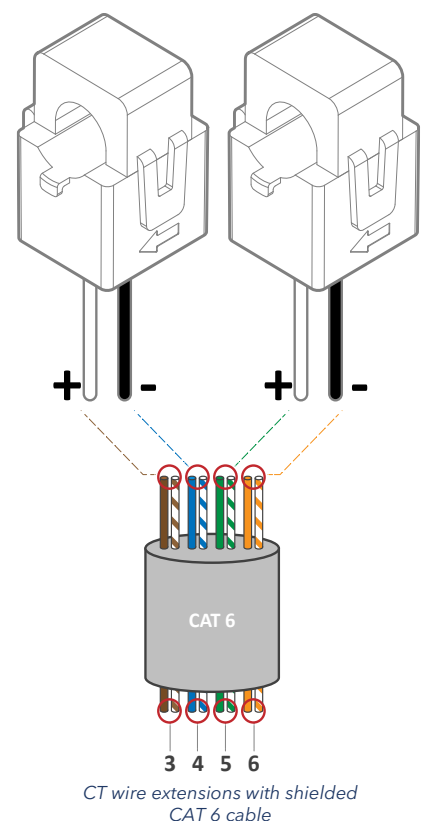

2.10 Emergency Stop and Rapid Shutdown

The (B, B) emergency stop pins of the Sol-Ark 15K-2P-N are an ordinarily open contact that triggers rapid shutdown (RSD) when closed. RSD will cut all power including the Sol-Ark's internal power supply and stop all AC outputs. The internal 12Vdc (-3%) power supply of the Sol-Ark (pins 15 & 16) will disconnect any RSD transmitter that will then shut down all solar panels when the emergency stop button is pressed.

- Emergency stop button connects to (B, B) pins of the Sol-Ark.
- RSD transmitter connects to pins 15 & 16 (12Vdc power supply)
- Transmitters placed inside the user area of the Sol-Ark can cause interference.

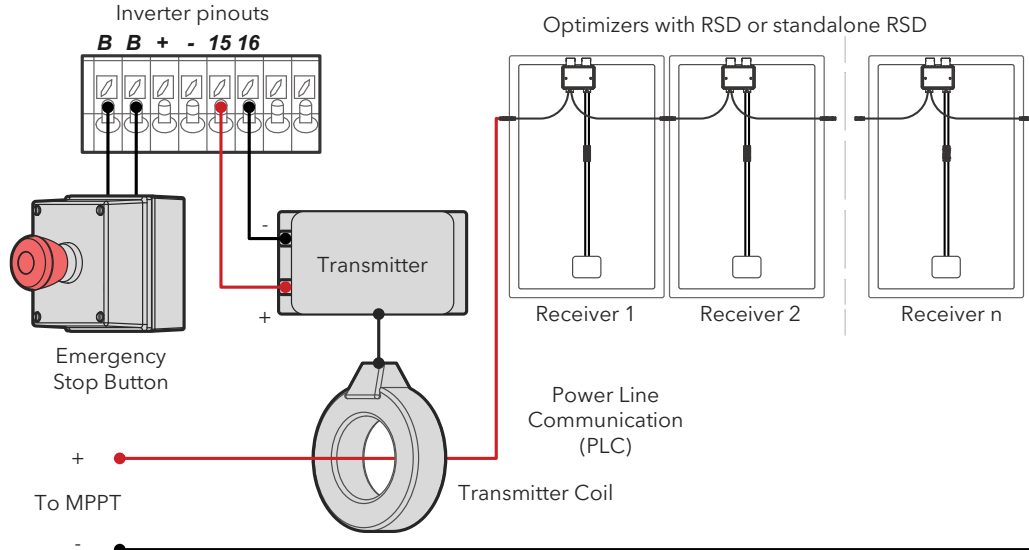

RSD Warning!
 The Built-in 12Vdc power supply of the Sol-Ark 15K-2P-N (Pins 15 & 16) is rated for **100mA (1.2W)**. Do not exceed!
 If unsure of the current (A) rating of the transmitter, contact the manufacturer before connecting

A transmitter that exceeds the maximum 100mA limit can still be integrated into the Sol-Ark inverter through an external power supply connected to the "LOAD" output. Pressing the e-stop button will disconnect all AC outputs, cutting power to the "LOAD" service panel which will initiate rapid shutdown.

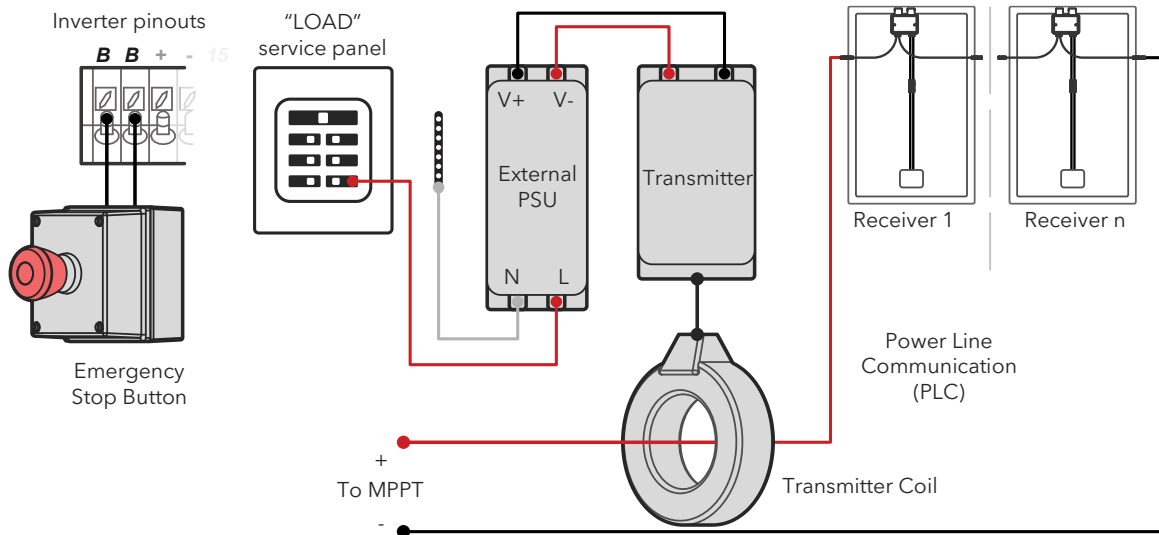

Rapid Shutdown Recommendations

TIGO TS4-A-O

TIGO TS4-A-F

TIGO TS4-O

TIGO TS4-O-DUO

APsmart RSD S-PLC / RSD-D

2.11 Powering-up and Testing the Sol-Ark

! TURN ON the inverter with at least one power source: 1) Battery, 2) PV or 3) Grid

1. Check the voltage of the battery bank

- ⚠ Voltage of the battery must be between $43V_{DC}$ - $63V_{DC}$.
- If applicable, turn **ON** internal switches of the batteries. Measure individual voltages.
- Verify that the voltage of the battery bank at the Sol-Ark terminals is adequate.
- ⚠ **DO NOT** reverse polarity. **DO NOT** turn **OFF** battery disconnect if any current is flowing in or out of the battery.

2. Check the voltage of each PV input circuit

- ⚠ Input voltage must not exceed $500V_{DC}$.
- Input voltage must be above the startup voltage of $125V_{DC}$.
- ⚠ Do not ground PV+ or PV-.
- ⚠ Verify polarity in each PV string. Backward polarity will measure $0V_{DC}$ by the Sol-Ark and will cause long term damage.
- ! PV alone turns LCD screen only. Inverter requires **grid** and/or **batteries** to operate, otherwise an "OFF" message will appear.
- PV DC disconnect switch on the side of the inverter will turn the PV ON or OFF.

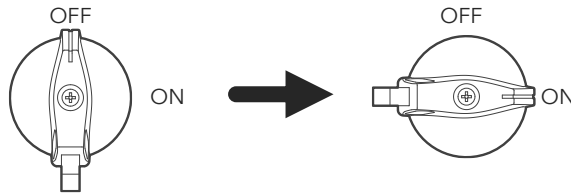

3. Check GRID input voltage

- Use the "GRID" terminals to measure AC voltage with a multimeter.
- Measure line (L) to neutral (N) voltages on "GRID" terminals. Ensure $120V_{AC}$ on all phases.
- Measure line (L) to line (L) voltages on "GRID" terminals. Ensure $240V_{AC}$. (If voltage reading is close to 220V or 210V, verify if grid is single-phase or three-phase instead).
- Verify that voltage between Neutral and Ground is $0V_{AC}$.
- Verify that voltage between "GRID" L1 and "LOAD" L1 is $0V$. Do the same for L2.

4. Power ON Sol-Ark 15K-2P-N

- Turn **ON** the battery breaker(s).
- PRESS** down the power button to the **ON** position. Wait for the "Normal" LED indicator to turn on. This may take a few minutes.
- Turn **ON** the PV DC disconnect switch. Wait for "DC" LED indicator to turn on.
- Turn **ON** the external "GRID" disconnect. Wait for "AC" LED indicator to turn on.
- Turn **ON** the internal "LOAD" and external "GEN" breakers.

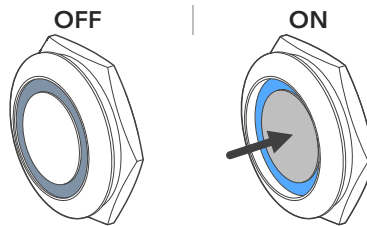

2.12 Power Cycle Sequence

- TURN OFF** all AC breakers / disconnects ("GRID", "GEN" and "LOAD").
- TURN OFF** the built-in PV DC disconnect switch on the side of the inverter.
- PRESS** the power button, making sure it is in the **OFF** position. An "OFF" message will appear after the "Normal" LED turns off.
- TURN OFF** the battery breakers.
- Wait a moment (~1 min) to ensure the inverter is completely de-energized.
- Make sure that the Sol-Ark is properly connected to the batteries, solar panels, "GRID", "GEN", and "LOAD".
- Reverse the steps to turn **ON** the Sol-Ark.

3. User Interface

3.1 LED Indicators

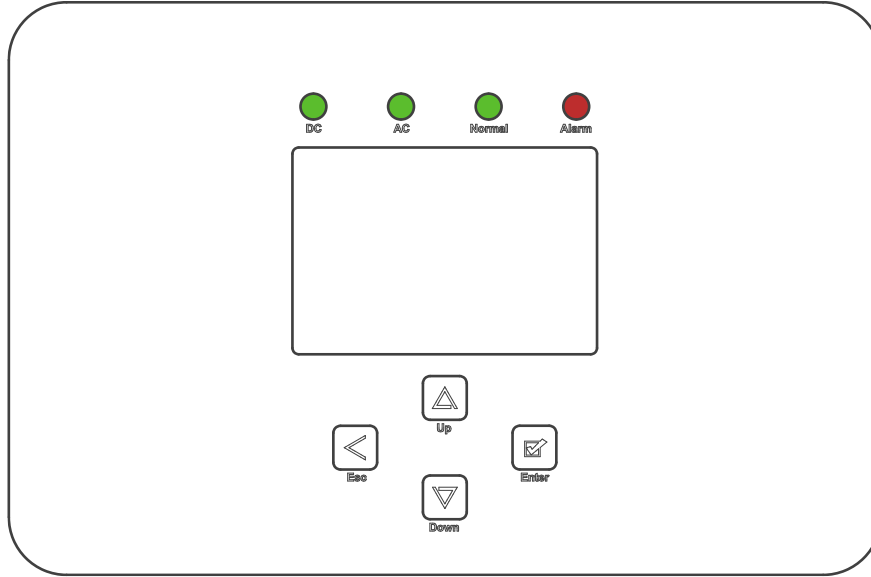

DC	AC	Normal	Alarm
Green → DC Solar Panels connected and providing voltage.	Green → Grid is connected and providing voltage.	Green → Sol-Ark is fully energized* and inverting power.	Red → Alarm state. Check the alarms menu. Home Screen → ⚙️ → "System Alarms"
OFF → Minimum MPPT voltage not met, wrong polarity or no PV _{DC} .	OFF → Grid voltage out of range or Off-Grid system.	OFF → Not fully energized*, in fault state or in passthrough mode.	OFF → No alarms / error codes / setting change notifications

! **Fully energizing the unit constitutes at least: a) DC Solar panels **AND** Grid or b) Just batteries*

3.2 Main Menu

✓ Solar Today=0.0 KWH Total=0.0 KWH ⚙️

19.50 KW

0.00 KW

0.00 KW

100% KW

Solar	Grid	INV	USP LD	Batt
0W	0W 0.0Hz	0W 0.0Hz	0W 0V	0W 0V
M1: 0V 0.0A 0W	0V HM: 0W	0V LD: 0W	0V 0W	0V 0.0A
M2: 0V 0.0A 0W	0V	0V	Gen	TEMP
M3: 0V 0.0A 0W	HM: 0W LD: 0W	0.0A 0W	0V 0.0Hz 0W	DC: 0.0C AC: 0.0C

System Setup 📶 10/14/2022 03:05:27 PM Fri.

Basic Setup

Battery Setup

Limiter

System Alarms

Only w/ BMS Lithium Mode

Li-Batt Info

Sol-Ark 5K/8K/12K/15K-P
- ID: #####
- COMM: ####
- MCU: Ver####

System Alarms 1/25/2021 03:05:27 PM Mon.

Alarms Code	Occurred
F13 Grid_Mode_changed	2021-01-13 11:22
F13 Grid_Mode_changed	2021-01-13 11:20

0.00 V	0.00 A	0.0 C	0%	0 Ah
0.0 V	0.0 V	0A	0A	0x00 0x00

Only w/ BMS Lithium Mode

1. 0.00V 0.00A 0.0C 0.0%	0.0V 0.0A 0 0 0
2. 0.00V 0.00A 0.0C 0.0%	0.0V 0.0A 0 0 0
3. 0.00V 0.00A 0.0C 0.0%	0.0V 0.0A 0 0 0
4. 0.00V 0.00A 0.0C 0.0%	0.0V 0.0A 0 0 0
5. 0.00V 0.00A 0.0C 0.0%	0.0V 0.0A 0 0 0
6. 0.00V 0.00A 0.0C 0.0%	0.0V 0.0A 0 0 0
7. 0.00V 0.00A 0.0C 0.0%	0.0V 0.0A 0 0 0
8. 0.00V 0.00A 0.0C 0.0%	0.0V 0.0A 0 0 0
9. 0.00V 0.00A 0.0C 0.0%	0.0V 0.0A 0 0 0
10. 0.00V 0.00A 0.0C 0.0%	0.0V 0.0A 0 0 0
11. 0.00V 0.00A 0.0C 0.0%	0.0V 0.0A 0 0 0
12. 0.00V 0.00A 0.0C 0.0%	0.0V 0.0A 0 0 0
13. 0.00V 0.00A 0.0C 0.0%	0.0V 0.0A 0 0 0

1. Main screen

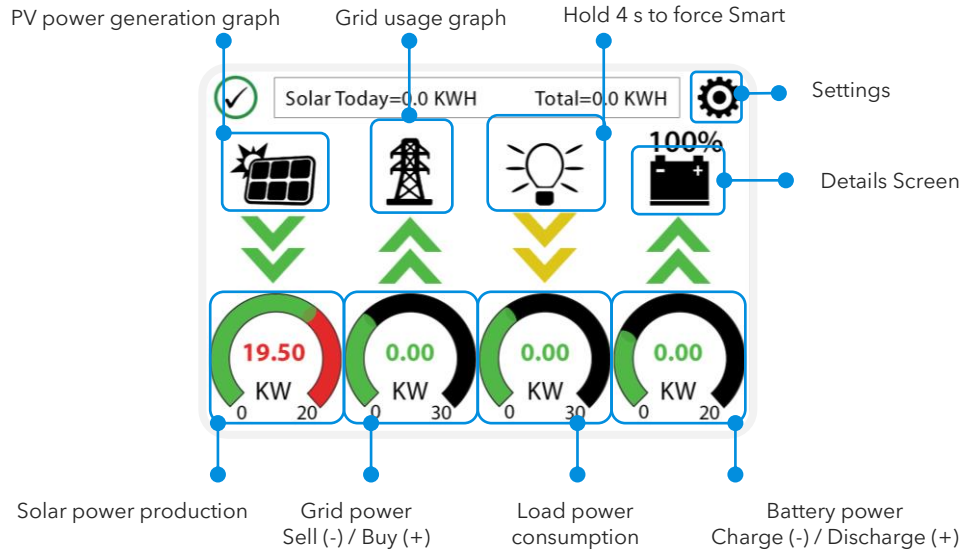

2. Details Screen

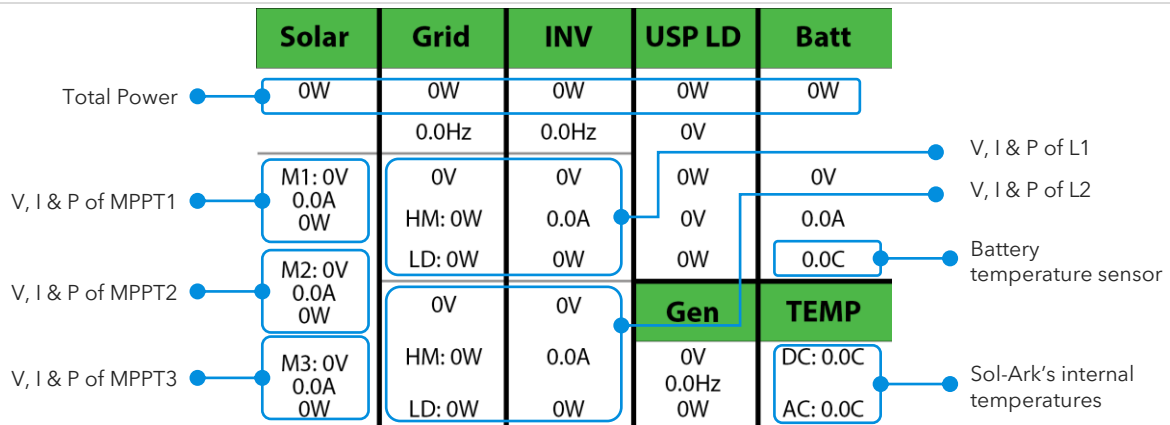

- ⚠️ MPPT voltages **MUST NOT** exceed 500V.
- Battery temperature will measure 25°C by default if the battery sensor is not connected.
- ❗ DC Temp: Sol-Ark 15K-2P-N does not have internal DC temperature sensors. Temperature reading can be ignored.
- AC Temp: Internal AC conversion side temperature.
- "Grid" column measures: Voltage, Current, Power and frequency of the utility grid.
 - If selling to the Grid, Watts = negative (-)
 - If buying from the Grid, Watts = positive (+)
 - HM: power measured by the external CT sensors. (L1, L2).
 - LD: power measured by the internal sensor on "GRID" terminal. (L1, L2).

❗ Opposing "Grid" or "HM" values indicate an incorrect installation of CT. See section 2.9 "Limit Sensor"

3. PV power Generation Graph

- Display power production over time for the PV array.
- Use up/down arrows (↑, ↓) to navigate between days.
- Month view/ year view/ total production.

4. Grid Usage Graph

- A. Displays power drawn from grid (+) / sold to the grid (-).
- B. Values above the line indicate "power bought" from the grid.
- C. Values below the line indicate "power sold back" to the grid.
- D. This view can help to determine when the peak power is used from the grid.

5. System Setup Menu

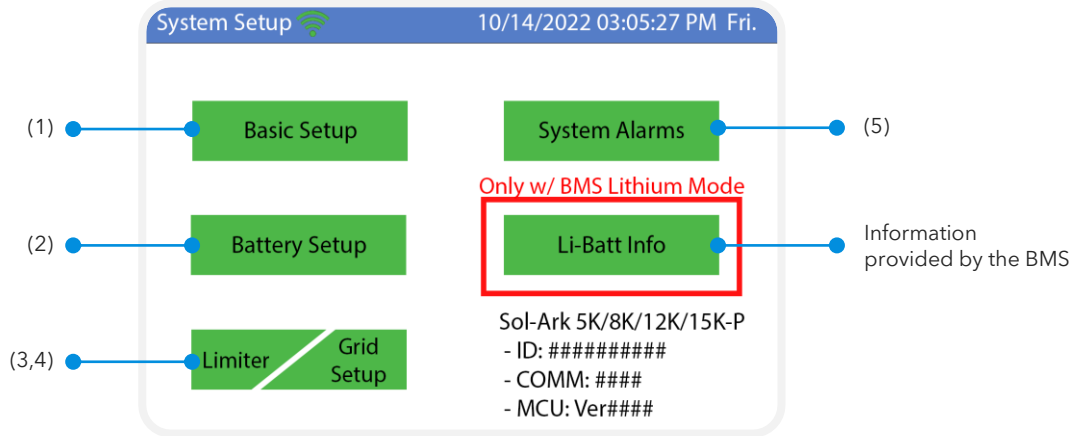

3.3 Basic Setup

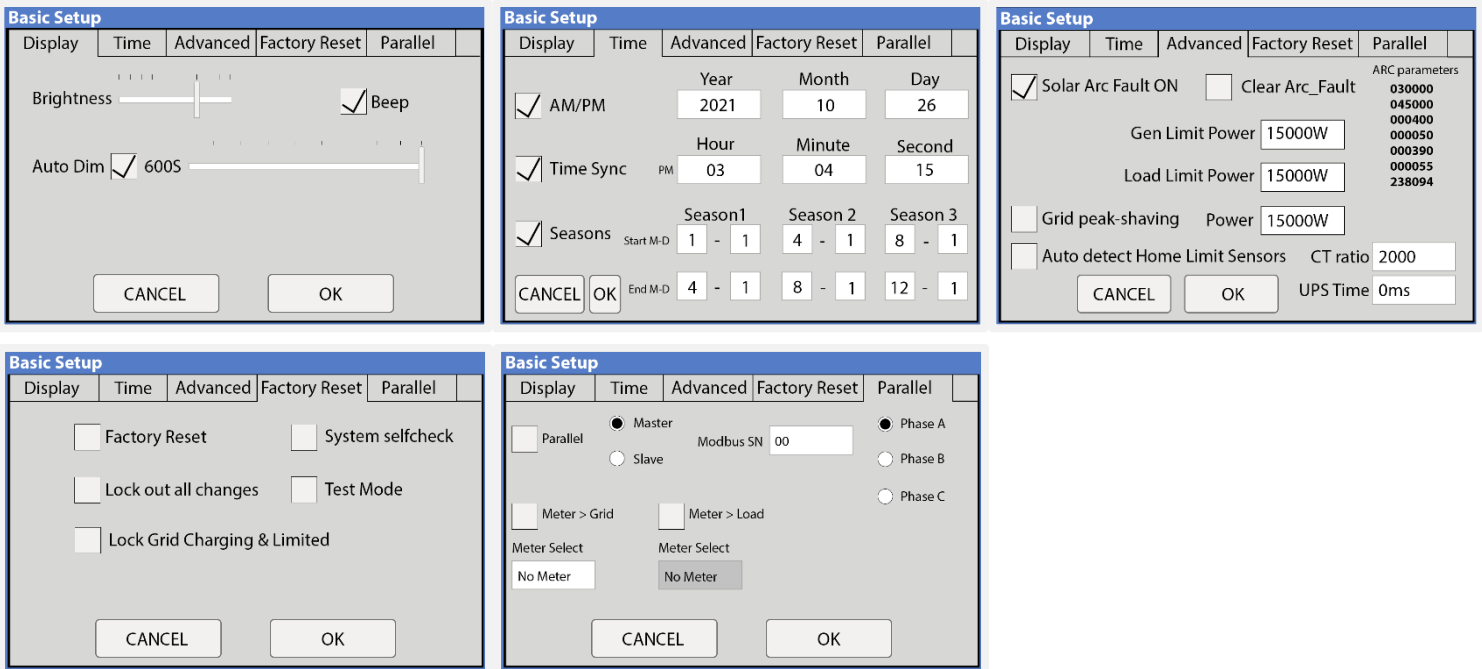

Display

Brightness: Brightness adjustment (+, -).

Auto Dim: ⚠️ Must be enabled at all times to validate the warranty of the LCD screen.

Beep: Enable / disable the alarm sound.

Time

Time Sync: Automatically syncs with the internet for daylight saving time changes (Enabling "Time sync" is recommended).

Seasons: Setup and customize the seasons for TOU.

Advanced

Solar Arc Fault ON: Enables Arc fault detection algorithm on the MPPTs.

Clear Arc Fault: Command to clear an Arc Fault.  It must be executed manually every time the system detects an F63 Arc_Fault alarm. See section 8.1 "Sol-Ark Error Codes" for more detail.

Gen Limit Power: Limits the power drawn from the "GEN" AC source. The inverter will reduce battery charge when value is reached.

Load Limit Power: Sets a limit to the total "LOAD" output power. The max output power of the inverter is programmed by default.

Grid-Peak Shaving: Sets a "GRID" consumption threshold that allows use of battery backup power during peak demand. External CT sensors are required. Peak shaving can be used on a generator provided it is wired to the "GRID" terminal.

Auto detect home Limit Sensor: Detects and auto-corrects the polarity of the CTs. See section 2.9 for details.

CT Ratio: Specifies the transformation ratio of the CT. Default value of 2000:1  **DO NOT** change or warranty will be voided.

UPS Time: Backup transfer time to essential loads upon grid disconnection. Default value of 5ms.

Factory reset

Restrictions: Changes to these settings must be previously authorized by Sol-Ark technical support agents.

Parallel

Parallel: Enables communications between parallel inverters. "Master" and "Slave" inverters must be programmed.

MODBUS SN: Identification number for each system configured in parallel (1,2,3,4, n).

Phase: When dealing with a 120/208V 3-Phase system, there must be a "Master" unit responsible of their own phase (A, B, C).

 See section 5 "Parallel Systems" for more information

3.4 Battery Setup

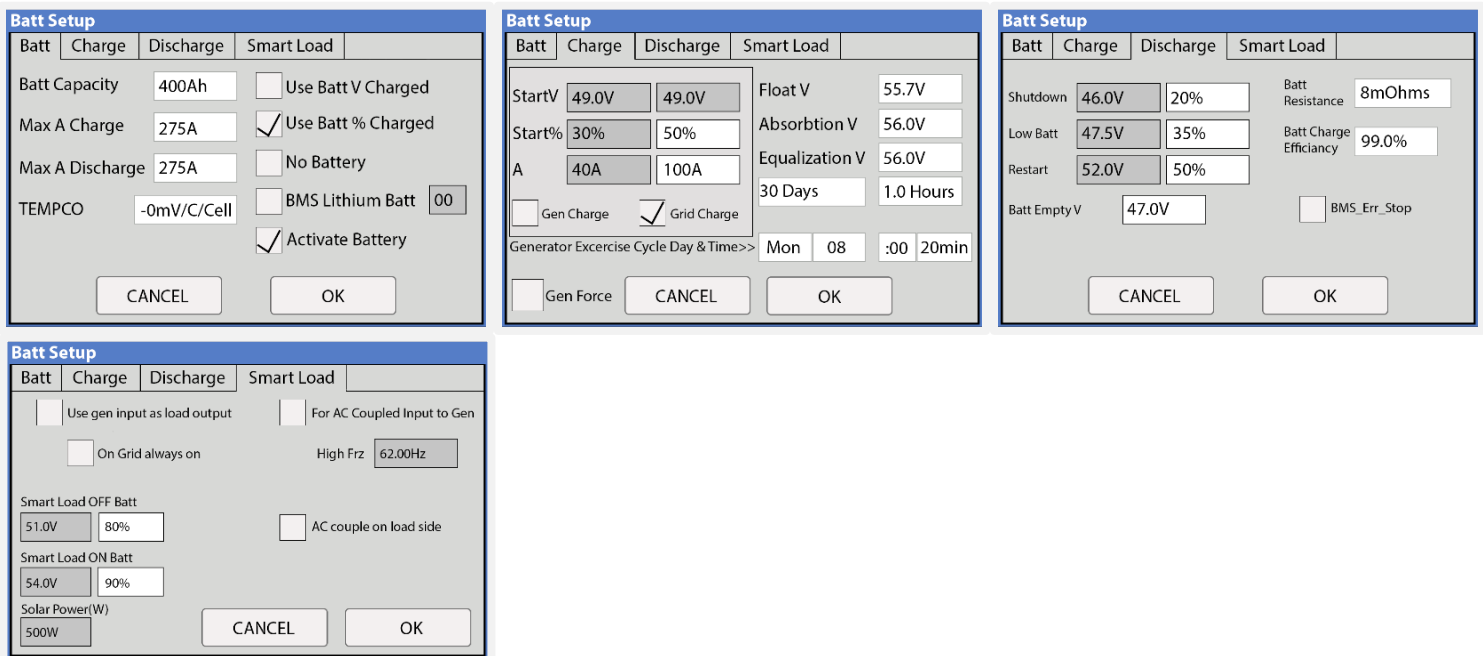

The image shows three screenshots of the 'Batt Setup' menu in a control interface. The first screenshot shows basic battery parameters: Batt Capacity (400Ah), Max A Charge (275A), Max A Discharge (275A), and TEMPCO (-0mV/C/Cell). It also has checkboxes for 'Use Batt V Charged', 'Use Batt % Charged', 'No Battery', 'BMS Lithium Batt' (set to 00), and 'Activate Battery'. The second screenshot shows charging and float settings: StartV (49.0V), Start% (30%), A (40A), Float V (55.7V), Absorbition V (56.0V), Equalization V (56.0V), and 30 Days / 1.0 Hours. It also includes 'Gen Charge', 'Grid Charge', and 'Generator Exercise Cycle Day & Time' (Mon 08 :00 20min). The third screenshot shows shutdown and efficiency settings: Shutdown (46.0V, 20%), Low Batt (47.5V, 35%), Restart (52.0V, 50%), Batt Empty V (47.0V), Batt Resistance (8mOhms), and Batt Charge Efficiency (99.0%). A fourth screenshot shows smart load settings: 'Use gen input as load output', 'On Grid always on', 'High Frz' (62.00Hz), 'Smart Load OFF Batt' (51.0V, 80%), 'Smart Load ON Batt' (54.0V, 90%), and 'Solar Power(W)' (500W).

Batt

Batt Capacity: Specifies the capacity of the battery bank. Value expressed in Amp Hour (Ah).

 Batteries in series → Voltage adds up (V).

 Batteries in parallel → Capacity adds up (Ah).

Max A Charge: Sets the maximum charge current (A) rate to the batteries when charged from solar power → 275A max allowed.

 Rule of thumb for Lead-Acid batteries: If manufacturer does not specify rated charge amps, use 20% - 30% of battery capacity as Max A Charge.

Max A Discharge: Sets the maximum discharge current (A) rate from the batteries → 275A max allowed.

For Off-Grid systems, the battery bank will discharge 120% of this value for a 10 second surge before the inverter faults to prevent battery damage.

TEMPCO: Temperature coefficient used in conjunction with the battery temperature sensor to adjust optimal voltages for lead-acid batteries.  Lithium batteries do not require a TEMPCO setting (-0 mV/C/Cell).

Use Batt V Charged: Displays battery charge in terms of voltage.

Use Batt % Charged: Displays battery charge in terms of %. The inverter uses algorithms measuring power in and out to estimate a true value for state-of-charge %. It compensates for aging batteries.

No Battery: "No Battery" option **MUST** be selected if there is no battery present. A power cycle sequence is **REQUIRED** when selecting this option. Refer to section 2.12 for power cycle instructions.

BMS Lithium Batt: Allows closed-loop communication with our tested batteries included in our "Battery Integration Guide". Refer to www.sol-ark.com/battery-partners for complete list of compatible batteries.

Activate Battery: This option **MUST** be selected if the system has batteries, especially **Lithium** batteries.

Charge

Float V: Lower steady voltage at which the battery is maintained after being fully charged.

Absorption V: Constant voltage used to charge the battery.

- Absorption will stop at 98% of the capacity of the battery bank and then drop to the Float setpoint.
- Example: A 400Ah battery will stop charge reaching 392Ah.

Equalization V: Voltage that the system uses to generate a calculated overcharge, utilizing a higher voltage or equal to the absorption to remove the generation of sulfates in batteries. Used to balance internal cells.  Most Lithium batteries do not need to equalize.

Days: The period between equalization cycles.

Hours: The period taken to equalize batteries.

 If "Hours" is set to 0 hours, the system will not equalize batteries.

Gen Charge: Uses the "GEN" input of the system to charge the battery bank from a generator.

- Start V:** Voltage at which the system will AutoStart a generator to charge the battery.
- Start %:** Percentage S.O.C (state of charge) at which the system will AutoStart a generator to charge the battery.
- A:** Maximum rate of charge of the batteries from the generator (DC amps).

Grid Charge: There are two scenarios in which this option is used:

- Grid connected to "Grid" input:** The inverter will limit the charge rate to the set value in "A" and the battery will charge to 100% SOC.
- Generator connected to "Grid" input:** It will be necessary to select " GEN connect to Grid input". The system will use "Start V", "Start%" and "A" conditions to charge the battery and stop charging at 95% SOC.  Adjustable upper limit if Time of Use is enabled.

Gen Exercise Cycle (Day & Time): Set a weekly generator exercise schedule. (Day of the week/time/duration length).

Gen Force: Test function for generator auto-start. Enable and press OK to close normally open relay (pins 7,8) and force the generator on. Disable and press OK to disengage. The generator will not provide power during this test if grid power is available.

 *The gen must be in automatic mode if applicable and must have a two-wire start (dry-contact, normally open) connected to the Sol-Ark. To disable the Gen exercise, adjust the time duration to 0 min.*

Discharge

Shutdown: Battery voltage or % at which the inverter will shut down to protect the battery from an over discharge situation (battery symbol on the home screen will turn red).

Low Batt: Low battery voltage or % (battery symbol on the home screen will turn yellow). Stopping point for TOU.

Restart: Battery voltage or % at which AC output will resume after previously reaching "shutdown".

Batt Resistance: Internal resistance of mOhms from the battery bank. Used in % SOC batt calculations.

Batt Charge Efficiency: Value provided by battery manufacturer. Used in % SOC batt calculations.

Batt Empty V: Sets the empty voltage and associates this voltage to 0% charge. This value determines the lowest % SOC limit.

BMS_Err_Stop: Enables system stop when there is loss of battery communications.

 **Continuous GEN input/output of 80A. DO NOT EXCEED.**

Smart Load

- This mode uses the "GEN" input as a load output that delivers power when the battery exceeds a user programmable threshold or when the Sol-Ark is connected to the grid.
- When " Use gen input as load output" is enabled, the "GEN" input terminal turns into an output to power high-power loads such as a water heater, irrigation pump, AC unit, pool pump, or any other loads.



- C. When " **On Grid always on**" is enabled, the "GEN" terminal will always output power as long as the grid is connected, regardless of battery charge.

Smart Load OFF Batt: Battery voltage or % at which the "GEN" terminal will stop outputting power.

Smart Load ON Batt: Battery voltage or % at which the "GEN" terminal will start outputting power.

Solar Power (W): Amount of PV production needed before "GEN" terminal starts outputting power.



AC Coupling Settings - (For AC Coupled Input)

- A.  Grid-tied systems with AC coupled solar arrays must have " **Grid Sell**" enabled. Ensure you are allowed to sell back to the grid.
- B. To use the "GEN" terminal as an AC coupling input for micro inverters or string inverters, enable " **For AC Coupled Input to Gen**".
- C.  In off-grid systems, the Sol-Ark will use frequency shifting to control the AC coupled solution based on the battery SOC. The meaning of "Smart Load OFF Batt" and "Smart Load ON Batt" will change in this mode.

Smart Load OFF Batt: The % SOC at which the AC coupled inverters turn OFF.  90% recommended.

Smart Load ON Batt: The % SOC at which the AC coupled inverters turn ON.  80% recommended.

To use the "LOAD" terminal for AC coupling microinverters or grid-tied string inverters:

- Must select " **AC couple on load side**".
-  The "GEN" terminal **CANNOT** be used. AC coupling on the "LOAD" terminal prevents the use of the "GEN" terminal for any other purpose.
- Wire as shown in diagram labeled "AC Coupling in LOAD".
-  Backup Transfer Time is extended to 2 seconds.

3.5 Limiter

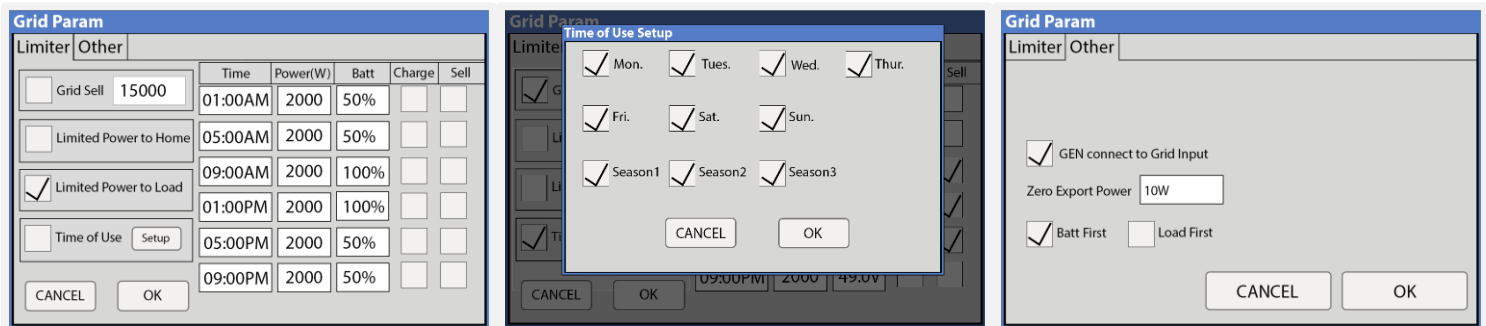

Limiter

The Sol-Ark 15K-2P-N inverter will simultaneously utilize different available power sources to satisfy load demand in the electrical service panels (essential loads panel / main service panel). The following work modes allow the user to determine how generated power is utilized.

Grid Sell

Grid Sell: The inverter will produce as much power as it has available from PV array according to the programming. The maximum power that can be sold to the grid will be 15,000W.

General description:

- This mode allows your inverter to sell back to the grid all the excess power generated from the PV arrays without limitation.
- The inverter will only show loads connected to the "LOAD" terminal.
- The inverter will measure all power in / out of the "GRID" terminal as grid consumption or grid sell back.

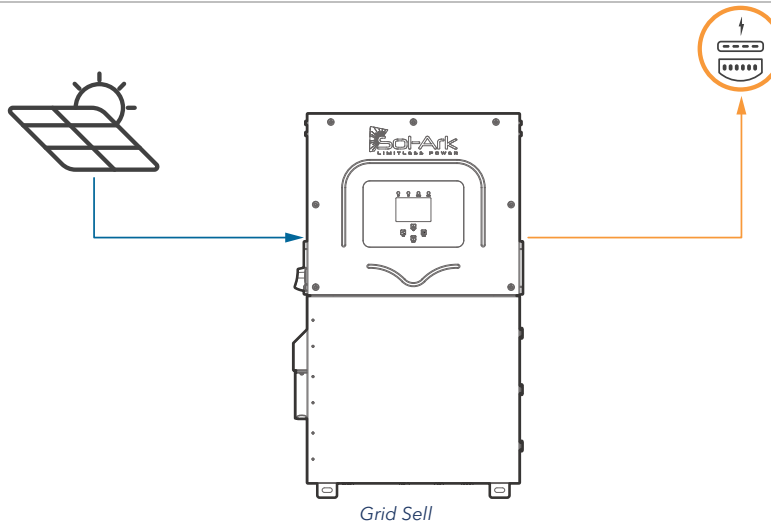

Limited Power to Home

This work mode **REQUIRES** batteries

Limited Power to Home (Meter Zero): This mode limits the energy produced by the inverter to satisfy the home demand (essential loads panel + main service panel). In this mode, the inverter delivers power to the "LOAD" terminal (essential loads panel) + the "GRID" terminal (main service panel). CT sensors **MUST** be installed. These sensors measure load consumption in the main service panel to offset total load demand and prevent selling to the utility. This system work mode is useful for users that don't have a permit to sell back. See section 2.9 "Limit Sensors" for proper external CT installation.

General description:

- a. Power is delivered to the whole home without selling the excess solar back to the grid (required if no permit to sell back from the utility company).
- b. External CT sensors **required** for proper operation of this system work mode.
- c. Monitored loads will be the addition of the main service panel + essential loads panel.
- d. **Energy Priority:** 1. Solar PV Power | 2. Grid Power | 3. Batteries | 4. Generator

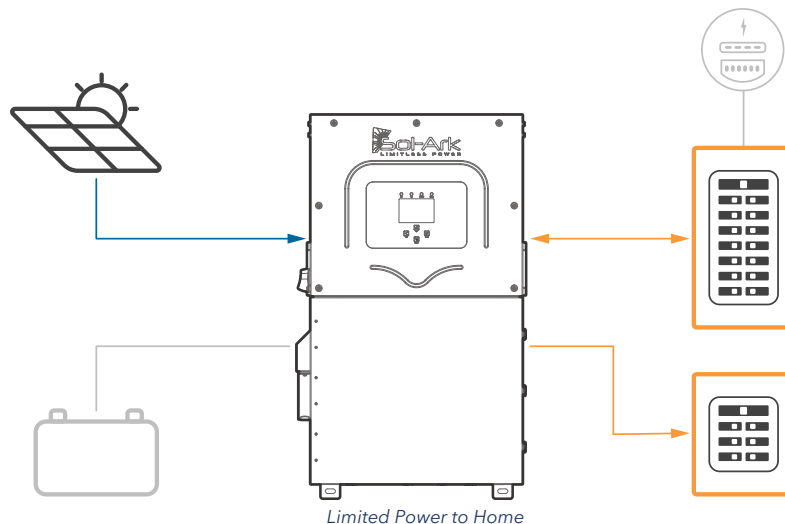

Limited Power to Home + Grid Sell: This mode will NOT limit solar production to home demand. In this mode, the inverter delivers power to the "LOAD" terminal (essential loads panel) + excess power to the "GRID" terminal (main service panel AND grid). The Sol-Ark will monitor grid sell and load consumption simultaneously (with +/- 3% error from CT sensors). The CT sensors **MUST** be installed. The inverter will sell excess solar power up to a programmable limit. See section 2.9 "Limit Sensors" for proper external CT placement.

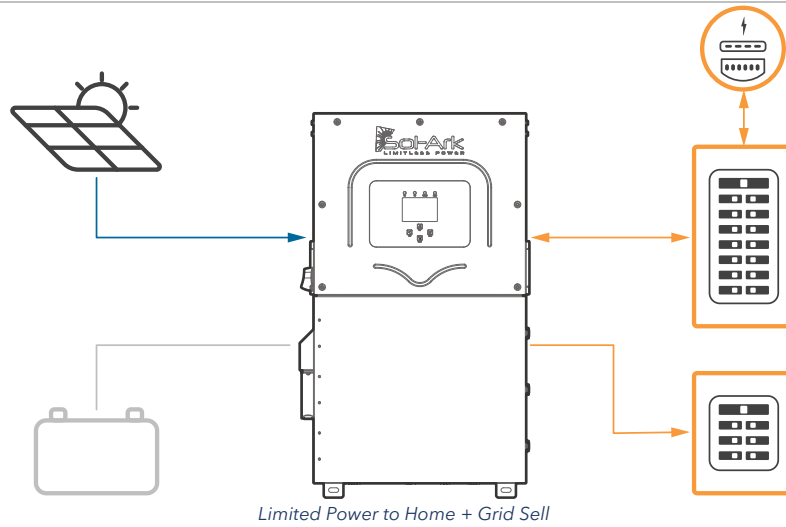

Limited Power to Load

! This work mode **REQUIRES** batteries

Limited Power to Load: This mode limits the solar production to cover "LOAD" demand (essential loads panel) exclusively. In this mode, the system disregards loads in the main service panel and will not deliver power to the "GRID" terminal.

General description:

- The inverter will only cover the loads connected to the "LOAD" terminal.
- It will **NOT** produce more power than the load demand.
- This work mode will **NOT** deliver power to the "GRID" terminal (will NOT sell back).
- The loads reported by the inverter will only be from the essential loads panel ("LOAD" terminal).
- This system work mode is recommended for off-grid applications.
- Energy Priority:** 1. Solar PV Power | 2. Grid Power | 3. Batteries | 4. Generator

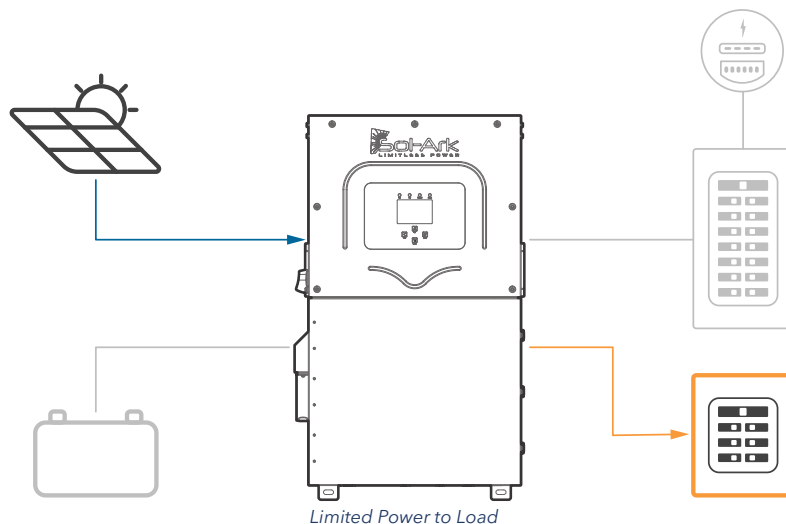

Limited to Load + Grid Sell: This mode will NOT limit solar production to "LOAD" demand. The inverter delivers power to the "LOAD" terminal (essential loads panel) + excess power to the "GRID" terminal (main service panel AND grid), however it will ONLY track "LOAD" demand and sell excess solar up to a programmable limit. "GRID" loads cannot be measured, only the total output through the "GRID" terminal. This mode is recommended for single inverter systems or for whole-home backup installations.

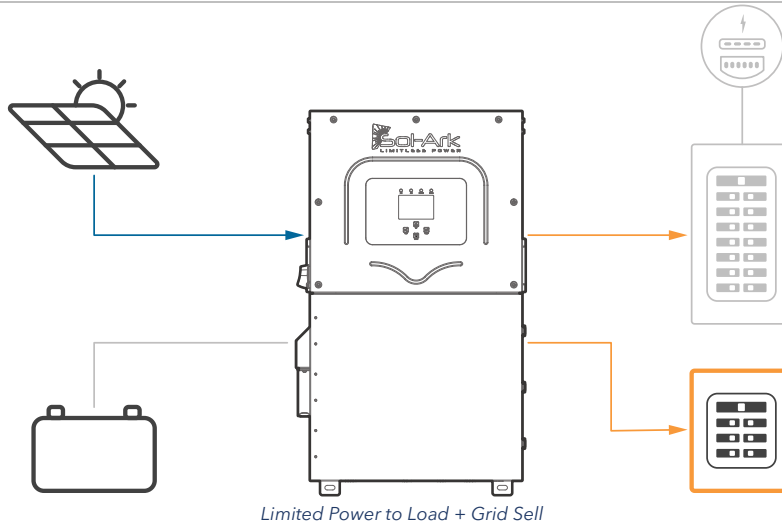

Time of Use

Time Of Use (TOU): This mode combined with “Limited Power to Home” or “Limited Power to Load” allows the use of battery backup power to reduce consumption from the grid during specific time intervals. Battery power will cover load demand at a programmable power rate “**Power(W)**” down to a programmable “**Batt (V / %SOC)**”. You can configure six different time intervals over a 24-hour period to cover a wide range of battery discharge or charge behaviors.

General description:

- Uses battery power to reduce the power consumption during user defined time intervals.
- Power (W) dictates the rate at which the battery discharges to assist with load demand.
- Batt (V or %) dictates the lower discharge limit or upper charge limit.
- Energy Priority:** 1. Solar PV Power | 2. Batteries (down to programmed discharge V or %) | 3. Grid Power | 4. Generator.

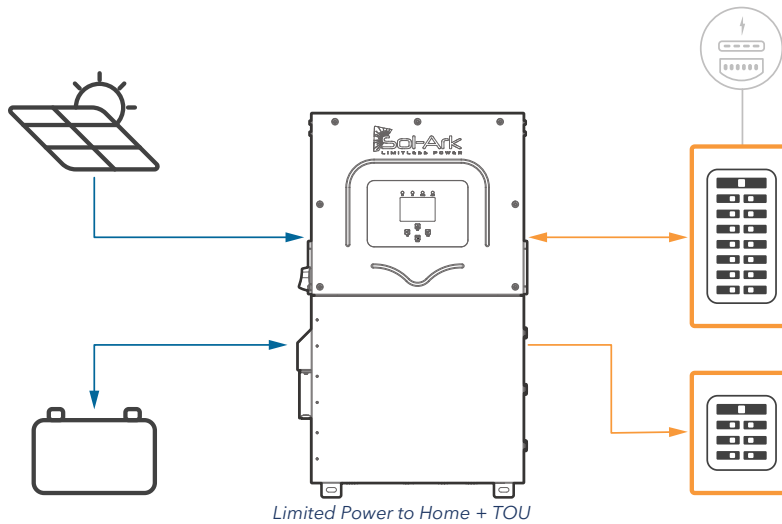

Time: Programmable time intervals over a 24h period. All time slots **MUST** follow chronological order and must be programmed.

Power(W): Sets the maximum discharge rate of the battery during the corresponding time slot.

Batt: V or % used to specify a lower discharge limit or upper charge limit whenever “ **Charge**” is enabled. ! Grid-tied systems will not allow TOU to discharge lower than “**Low Batt V/%**”. Off-grid systems allow TOU discharge down to “**Shutdown V/%**”.

Charge: During the hours selected, it is allowed to charge batteries from an external AC source up to a programmed voltage or %. If the external AC power source is a generator, the “Start V” or “Start %” condition must be fulfilled first. If available, the solar array will always charge the batteries at 100% regardless of “ **Charge**” in TOU.

Sell: Allows batteries to discharge and sell power to the grid at the programmable “Power(W)” rate. “ **Grid Sell**” **MUST** be enabled.

! Do **NOT** enable “Charge” and “Sell” at the same time

Other

GEN Connect to Grid Input: Specifies when a generator is connected to the “GRID” terminal.

Zero Export Power: Minimum power imported from the grid. Helps avoid selling back by ensuring constant grid consumption. The value can be set between 1 – 100W (recommended 20W).

Batt First:  Default and recommended option. Sets the solar power priority of the system to charge batteries first. Do NOT change unless instructed by Sol-Ark technical support.

Load First: Sets the solar power priority of the system to cover loads demand first and deliver remaining power to batteries.  Only recommended for very specific situations.

3.6 Grid Setup

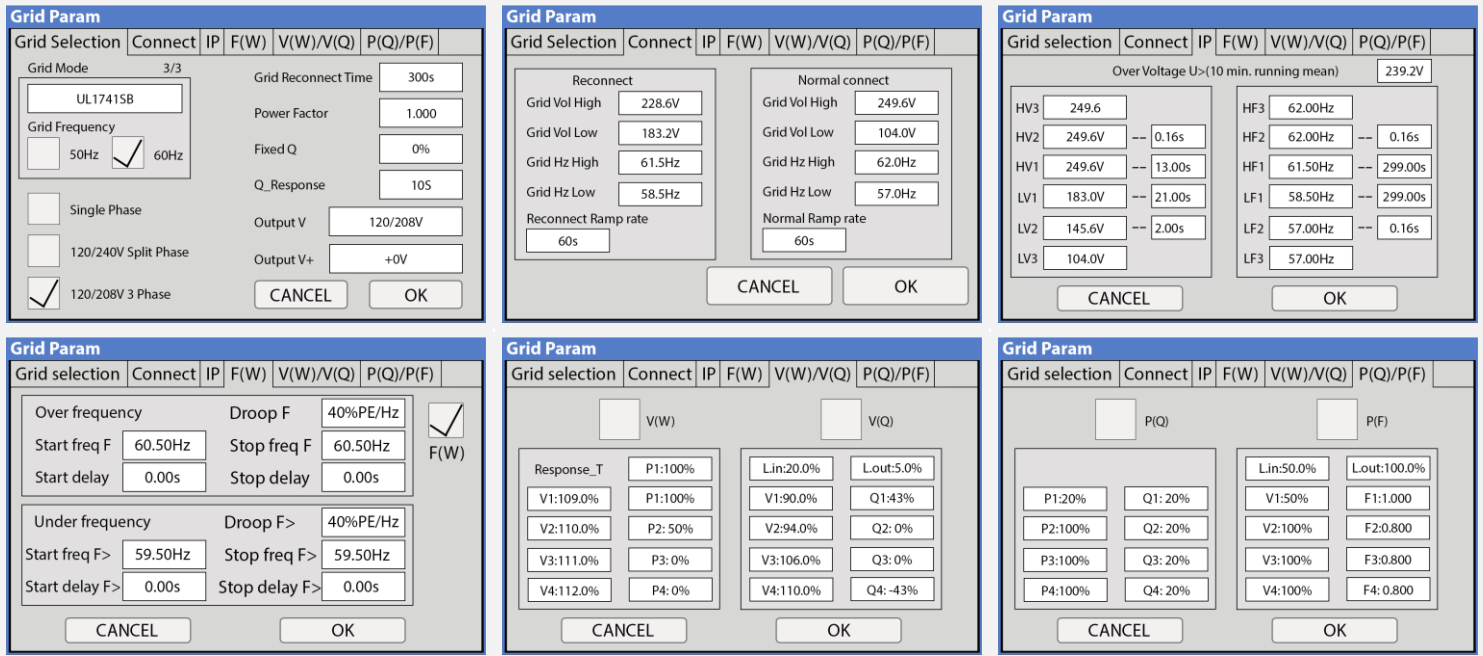

The image displays six screenshots of the Grid Setup configuration interface, arranged in a 2x3 grid. Each screenshot shows a different section of the configuration menu.

- Top Left:** Grid Param screen showing Grid Mode (UL1741SB), Grid Reconnect Time (300s), Power Factor (1.000), Fixed Q (0%), Q_Response (10s), Output V (120/208V), and Output V+ (+0V).
- Top Middle:** Grid Param screen showing Reconnect and Normal connect parameters for Grid Vol High/Low and Grid Hz High/Low, along with Reconnect Ramp rate (60s) and Normal Ramp rate (60s).
- Top Right:** Grid Param screen showing Over Voltage U>(10 min. running mean) (239.2V) and a table of HV/LV and HF/LF voltage and frequency settings.
- Bottom Left:** Grid Param screen showing Over frequency and Under frequency droop settings (Droop F and Droop F>).
- Bottom Middle:** Grid Param screen showing V(W) and V(Q) response settings (Response_T, P1, P2, P3, P4, Lin, Lout).
- Bottom Right:** Grid Param screen showing P(Q) and P(F) response settings (P1, P2, P3, P4, Q1, Q2, Q3, Q4, Lin, Lout, F1, F2, F3, F4).

Grid Selection

Grid Mode: Tap and use navigation arrows to cycle through different grid modes:

- General Standard:** Applies general grid interconnection standards. Enables grid frequency and voltage adjustments. (Useful for off-grid applications with backup generators).
- UL1741 & IEEE1547:** Applies UL 1741 and IEEE 1547 grid interconnection requirements and standards.
- UL1741SB:** Applies UL 1741SB grid interconnection requirements and standards.

Grid Frequency: Frequency of the AC sine wave.

Grid Type: Determines the type of system voltage and grid interconnection. Includes Single Phase, Split-Phase, and 3-Phase.

Grid Reconnect Time: The amount of time in seconds the inverter will wait before reconnecting to the grid.

Power Factor: Allows for power factor correction, ±0.9 to 1.0.

Fixed Q: Allows for power factor correction based on desired reactive power percentage.

Q_Response: Response time that will take to follow supported Volt-Var or Watt-Var reactive response modes.

Output V: Tap and use navigation arrows to cycle through different nominal grid voltage levels.  Grid level must be selected according to nominal grid voltage.

Output V+: Allows fine voltage modifications to the Output V to ensure proper nominal voltage.

Connect

Reconnect: Parameters used to determine an allowable range of frequency and voltages to dictate a reconnection to the grid after initial grid loss. Frequency and voltages must be within these margins during Grid Reconnect Time to allow grid reconnection.

 Parameters will be set automatically based on selected grid mode compliance, unless “General Standard” is selected.

Normal connect: Parameters used to determine an allowable range of frequency and voltages to retain connection to the grid following a reconnect and normal operation.

 Parameters will be set automatically based on selected grid mode compliance, unless “General Standard” is selected.

Reconnect Ramp Rate: Reconnection power ramp time in seconds.

Normal Ramp Rate: Startup power ramp time in seconds.

IP

HV1/HV2/HV3: Overvoltage protection point.

LV1/LV2/LV3: Undervoltage protection point.

HF1/HF2/HF3: Over frequency protection point.

LF1/LF2/LF3: Under frequency protection point.

F(W)

F(W): Enables the use of Frequency-Watt. The Sol-Ark regulates its power output to the grid as a function of the frequency to support grid stabilization during over and under-frequency conditions.

Droop F: Percentage of inverter's nominal power increase / decrease per Hert (Hz).

Start freq F: Frequency at which the inverter will start decreasing active power by the programmed Droop F percentage.

Stop freq F: Frequency at which the inverter will stop decreasing active power by the programmed Droop F percentage.

V(W) / V(Q)

V(W): Enables the use of Volt-Watt. The Sol-Ark regulates active power output to the grid as a function of voltage to support stabilization during over and under-voltage conditions.

V(Q): Enables the use of Volt-VAr. The Sol-Ark regulates reactive power output to the grid as a function of the voltage to support stabilization during over and under-voltage conditions.

V, P & Q: Percentage of nominal grid voltage (V) to which the Sol-Ark will reduce its active power (P) or reactive power (Q).

P(Q) / P(F)

P(Q): Enables the use of Watt-VAr to regulate reactive power output according to programable active power parameters.

P(F): Enables PF regulation according to programmable active power parameters.





Follow electrical grid code before changing grid settings

4. Installation Tips

Off-Grid Installation Tips

1. Limit sensors (CTs) are not required for completely off-grid installations unless using **"Grid Peak Shaving"** for a generator connected to the **"GRID"** terminal.
2. Connecting generators to the **"GRID"** terminal is recommended to facilitate the integration **"GEN"** connected service panel. This setup enables the utilization of the **"Smart Load"** function.
3. There is no need for a transfer switch. Connect the **"LOAD"** output to the main panel.
4. **DO NOT** use **"Grid Sell"** mode when Off-Grid. **ONLY "Limited Power to Load"** (default).
5. When using a Generator in an Off-Grid situation, it is recommended to change the **"Grid Mode"** to **"General Standard"** and a **"Grid Reconnect Time"** to 30 seconds. See section 2.5 **"Integrating a Generator"** for detailed instructions.
6. The Auto Gen-Start activates when the battery voltage (V) or percentage (%) reaches the pre-set **"Start V / %"** value. Subsequently, the generator will sustain the charging process until the batteries reach approximately 95% capacity.  This is a non-modifiable upper limit unless Time of Use is enabled and programmed.
 - o An exercise function will turn on the generator once a week on Monday mornings at 8 AM for 20 min by default. This exercise is to maintain the internal generator batteries.
7. If planning on integrating a wind turbine, a 48V charge controller with a dump load **MUST** be incorporated to prevent battery overcharge. This charge controller must be connected directly to the battery bank.
8. Remember to set the battery capacity and reasonable charge/discharge rates.

Grid-Tie and No Battery Install Tips (Passthrough mode)

1. Check the **" No Battery"** setting:  → *Battery Setup* → *Batt* → *No Battery*. The inverter will fault momentarily.
2.  A complete **Power Cycle IS REQUIRED** when changing the battery mode to **"No Battery"** (see section 2.12 **"Power cycle Sequence"** for detailed instructions).
3. Enable **" Grid Sell"**:  → *Limiter* → *Grid Sell*. *Make sure to disable all other modes.*
4. Tap the battery icon to access the **"Details Screen"** and verify grid parameters and power import / export.

4.1 Battery Charge Controller

4-Stage Charging

The MPPT has a 4-stage battery charging algorithm for rapid, efficient, and safe battery charging. The next figure shows the stage sequence.

Bulk Charge Stage

In the Bulk Charge stage, the battery is not at a 100% state of charge and has not yet reached the Absorption voltage setpoint. The controller will deliver 100% of available solar power to recharge the battery.

Absorption Stage

When the battery has reached the absorption voltage setpoint, the Sol-Ark inverter uses constant-voltage regulation to maintain battery voltage at the absorption setpoint, preventing overheating and excessive battery gassing. The battery is allowed to come to a full state of charge at the absorption voltage setpoint. Absorption lasts until the battery charge amperage (A) rate reaches 2% of the programmed capacity (Ah).

Float Stage

After the Absorption stage charges the battery fully, the MPPT reduces the battery voltage to the float voltage setpoint. If the batteries have 100% charge, there can be no more chemical reactions and all the charging current turns into heat and gassing. The Float stage provides a meager rate of maintenance charging while reducing the heating and gassing of a fully charged battery. The purpose of the Float stage is to protect the battery from long-term overcharge.

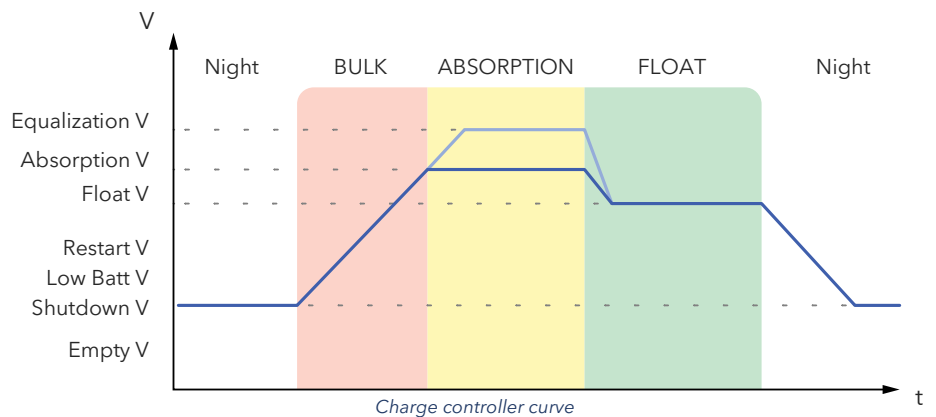

4.2 Grid Compliance Settings

Puerto Rico Grid Compliance Settings

Grid Param					
Grid selection	Connect	IP	F(W)	V(W)/V(Q)	P(Q)/P(F)
Over Voltage U>(10 min. running mean)					239.2V
HV3	288.0V			HF3	61.50Hz
HV2	288.0V	--	0.16s	HF2	61.50Hz
HV1	264.0V	--	1.00s	HF1	60.50Hz
LV1	211.2V	--	2.00s	LF1	59.20Hz
LV2	144.0V	--	1.00s	LF2	57.50Hz
LV3	108.0V			LF3	57.50Hz
CANCEL			OK		

HECO Grid Compliance Verification for Sol-Ark

In cases where HECO compliance requirements are mandated, it is essential to program the following grid parameters in accordance with the HECO specifications. Follow the next GUI screens, program the settings, and verify alignment with HECO compliance.

120/240V

Grid Param					
Grid Selection	Connect	IP	F(W)	V(W)/V(Q)	P(Q)/P(F)
Reconnect			Normal connect		
Grid Vol High	252.0V			Grid Vol High	252.0V
Grid Vol Low	211.2V			Grid Vol Low	211.2V
Grid Hz High	60.1Hz			Grid Hz High	60.1Hz
Grid Hz Low	59.5Hz			Grid Hz Low	59.5Hz
Reconnect Ramp rate	300s			Normal Ramp rate	300s
CANCEL			OK		

Grid Param					
Grid selection	Connect	IP	F(W)	V(W)/V(Q)	P(Q)/P(F)
Over Voltage U>(10 min. running mean)					276.0V
HV3	288.0V			HF3	65.00Hz
HV2	288.0V	--	0.16s	HF2	65.00Hz
HV1	264.0V	--	13.00s	HF1	63.00Hz
LV1	211.2V	--	21.00s	LF1	57.00Hz
LV2	168.0V	--	2.00s	LF2	50.00Hz
LV3	120.0V			LF3	49.90Hz
CANCEL			OK		

120/208V

Grid Param					
Grid Selection	Connect	IP	F(W)	V(W)/V(Q)	P(Q)/P(F)
Reconnect			Normal connect		
Grid Vol High	218.4V			Grid Vol High	218.4V
Grid Vol Low	183.1V			Grid Vol Low	183.1V
Grid Hz High	60.1Hz			Grid Hz High	60.1Hz
Grid Hz Low	59.5Hz			Grid Hz Low	59.5Hz
Reconnect Ramp rate	300s			Normal Ramp rate	300s
CANCEL			OK		

Grid Param					
Grid selection	Connect	IP	F(W)	V(W)/V(Q)	P(Q)/P(F)
Over Voltage U>(10 min. running mean)					239.2V
HV3	249.6V			HF3	65.00Hz
HV2	249.6V	--	0.16s	HF2	65.00Hz
HV1	228.8V	--	13.00s	HF1	63.00Hz
LV1	183.0V	--	21.00s	LF1	57.00Hz
LV2	145.6V	--	2.00s	LF2	50.00Hz
LV3	104.0V			LF3	49.90Hz
CANCEL			OK		

Frequency-Watt, Volt-Watt and Volt-Var

Grid Param					
Grid selection	Connect	IP	F(W)	V(W)/V(Q)	P(Q)/P(F)
Over frequency			Droop F		50%PE/Hz
Start freq F	60.04Hz			Stop freq F	60.50Hz
Start delay	0.00s			Stop delay	0.00s
Under frequency			Droop F>		50%PE/Hz
Start freq F>	59.96Hz			Stop freq F>	59.50Hz
Start delay F>	0.00s			Stop delay F>	0.00s
CANCEL			OK		

Grid Param					
Grid selection	Connect	IP	F(W)	V(W)/V(Q)	P(Q)/P(F)
			<input checked="" type="checkbox"/> V(W)	<input checked="" type="checkbox"/> V(Q)	
Response_T			5S		
V1:106.0%	P1:100%			L.in:20.0%	L.out:5.0%
V2:110.9%	P2: 0%			V1:92.0%	Q1:44%
V3:110.0%	P3: 0%			V2:98.0%	Q2: 0%
V4:110.0%	P4: 0%			V3:100.0%	Q3: 0%
CANCEL			OK		

5. Parallel Systems

5.1 Before Enabling Parallel Operations

- A. Make sure all units in parallel have the same software version by verifying the **"COMM"** and **"MCU"** numbers on System Setup.
- B. Go to <https://www.sol-ark.com/software-update/> to schedule an update or call/email Tech Support for assistance: support@sol-ark.com
- C. ⚠ Parallel systems **REQUIRE** a joint battery bank. If you do not have a battery, keep all Sol-Ark inverters **OUT** of parallel and set every System to **"Grid Sell"** Mode.
- D. All INPUTS/OUTPUTS must be shared among **ALL** parallel inverters, with the exception for DC solar inputs.

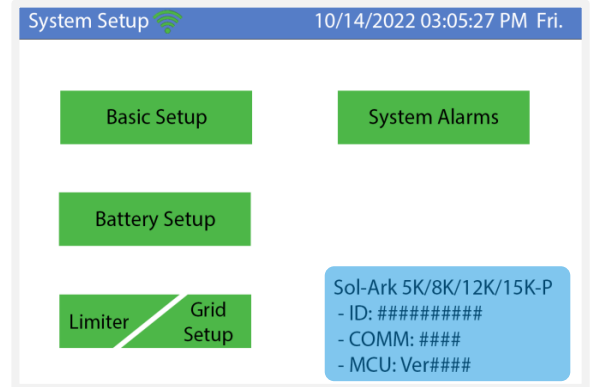

DIP Switch Configuration for Parallel Systems

In parallel systems, set the "DIP Switches" shown in the following, according to the table below.

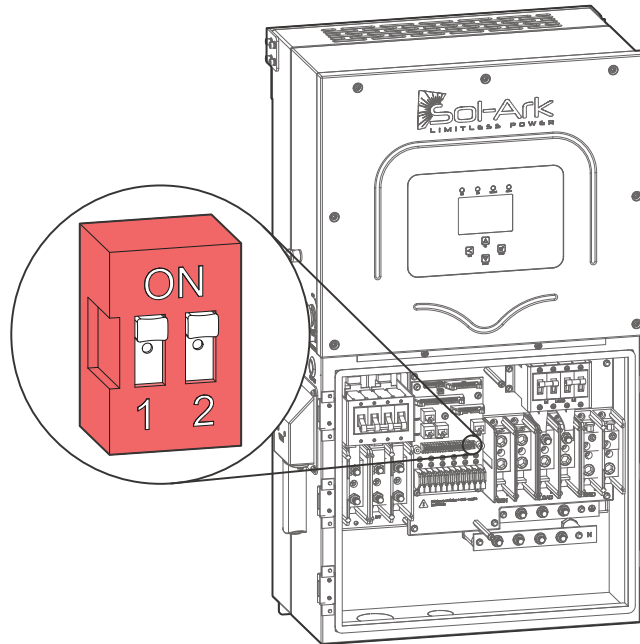

Inv 1 (Master)	Inv 2	Inv 3	Inv 4	Inv 5	Inv 6	Inv 7	Inv 8	Inv 9	Inv 10	Inv 11	Inv 12
OFF											
! ON	! ON										
OFF	ON	OFF									
OFF	ON	ON	OFF								
OFF	ON	ON	ON	OFF							
OFF	ON	ON	ON	ON	OFF						
OFF	ON	ON	ON	ON	ON	OFF					
OFF	ON	ON	ON	ON	ON	ON	OFF				
OFF	ON	ON	ON	ON	ON	ON	ON	OFF			
OFF	ON	ON	ON	ON	ON	ON	ON	ON	OFF		
OFF	ON	ON	ON	ON	ON	ON	ON	ON	ON	OFF	
OFF	ON	ON	ON	ON	ON	ON	ON	ON	ON	ON	OFF
OFF	ON	ON	ON	ON	ON	ON	ON	ON	ON	ON	ON

! Parallel systems with 2 inverters must have their DIP switches on the ON position

Parallel Systems Sol-Ark 15K-2P-N @ 120/240V Split-Phase

# of inverters in parallel	Continuous output power with PV (kW)	Continuous output power with batteries (kW)	Max. Grid Passthrough Current (A)	Peak power 10 sec (kVA)
1	15	12	200	24
2	30	24	400	48
3	45	36	600	72
4	60	48	800	96
5	75	60	1000	120
6	90	72	1200	144
7	105	84	1400	168
8	120	96	1600	192
9	135	108	1800	216
10	150	120	2000	240
11	165	132	2200	264
12	180	144	2400	288

Parallel Systems Sol-Ark 15K-2P-N @ 120/208V 3-Phase

# of inverters in parallel	Continuous output power (kW)	Continuous output power with batteries (kW)	Grid "Pass Through" (A)	Peak power 10 sec (kVA)
1 (only 2 phases)	13	12	200	24
2 (all phases but unbalanced)	26	24	400	48
3	39	36	400	72
6	78	72	800	144
9	117	108	1200	216
12	156	144	1600	288

5.2 Parallel Systems Programming Sequence

1. Program each inverter for parallel operation: ⚙️ → *Basic Setup* → *Parallel* → **Parallel**
2. Assign a **"Master"** inverter, **Modbus SN: 1**
3. Assign all other units as **"Slave"** | **Modbus SN: 2,3,4...** etc.
4. If system is 3-Phase, there MUST be a master for each phase (Master Phase A, Master Phase B, Master Phase C)
5. Connect communication cables between the inverters using the RJ45 cable (yellow ethernet cable) in daisy-chain configuration between ports: "Parallel_1" or "Parallel_2" from Master to Slave / Slave to Slave.
6. Perform a power cycle (see section 2.12 "Power Cycle Sequence" for power cycle sequence instructions).
7. Once the power cycle is completed, turn on the "Slave" units **FIRST**. Then turn ON the "Master" **LAST**.
8. Inverters will likely fault momentarily with F29 and F41 codes until all inverters are ON.

! When integrating a generator, it must be connected to all the systems in parallel. The inverter assigned as "Master" will control the two-wire start feature

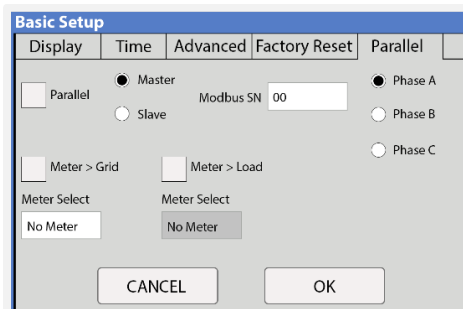

Parallel setup tab

Parallel Configuration (Example on a 3 Phase System-Balanced). Phase A-B-C

A 3-Phase balanced system requires at least 3 Sol-Ark Units. Programming and wiring should follow the below images.

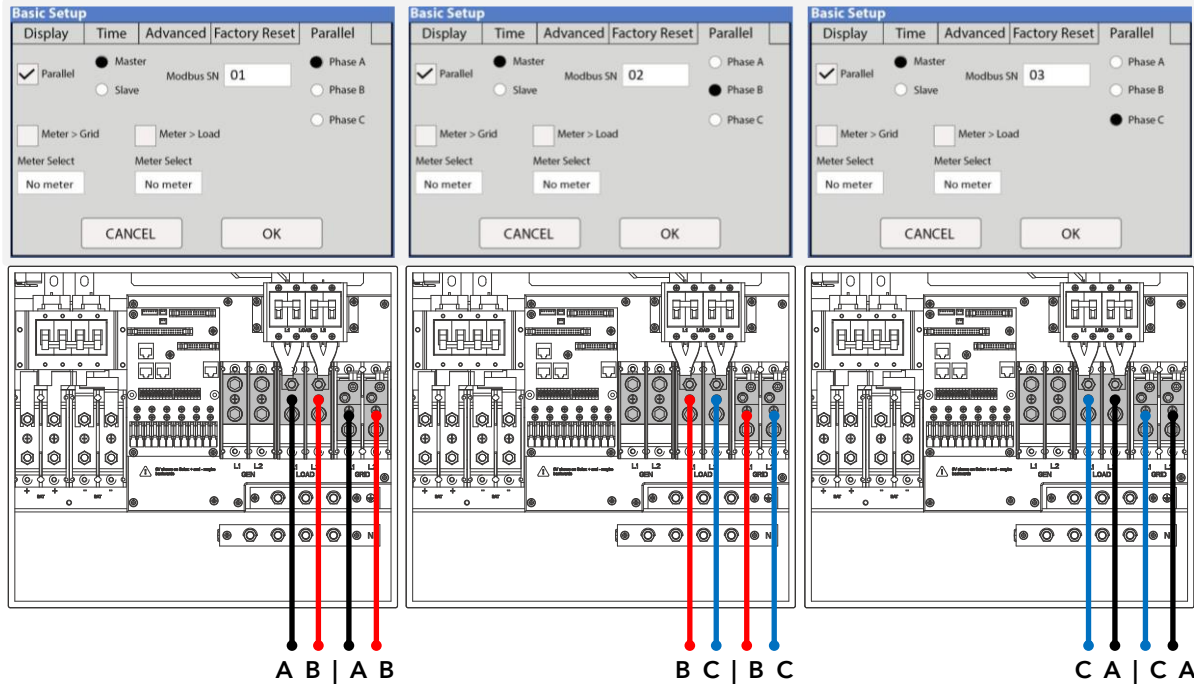

Examples of 3-Phase Parallel Configurations

1 inverter @ 120/208V
Using 2 phases of 3

2 inverters @ 120/208V
Using 2 phases of 3

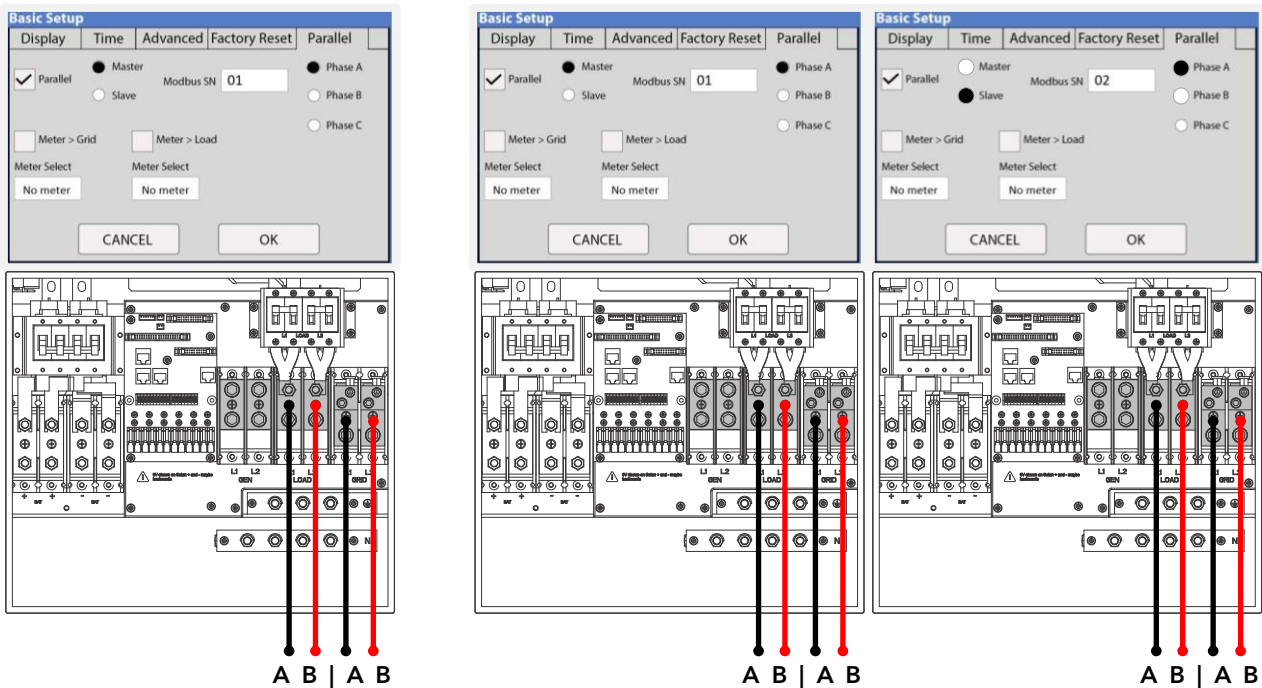

2 inverters @ 120/208V using 3 phases of 3 (Unbalanced)

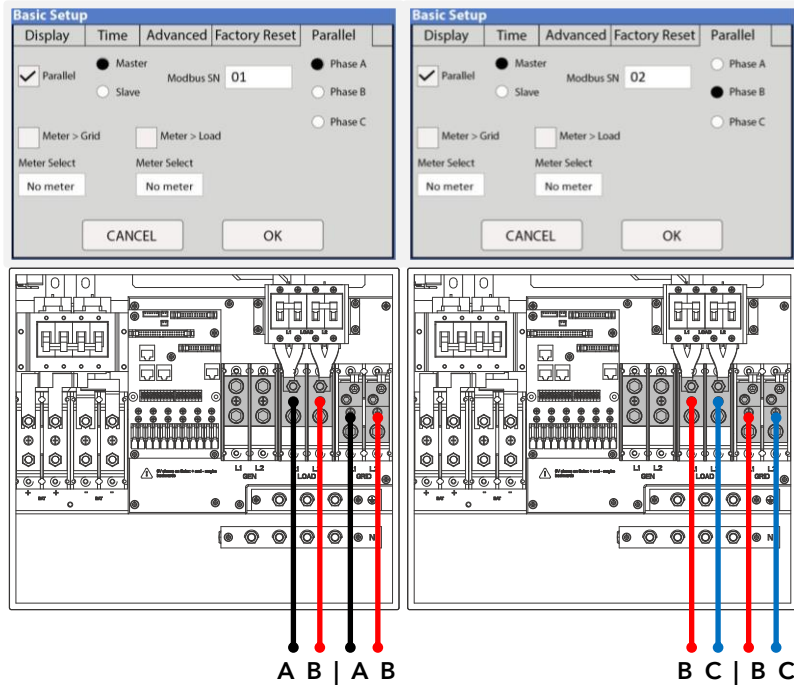

5.3 Three-Phase Systems

3-phase systems with multiple Sol-Ark inverters must be programmed according to the table below:

# of inverters	Programming
2	Master Phase A 01 Master Phase B 02
3	Master Phase A 01 Master Phase B 02 Master Phase C 03
6	Master Φ A 01, Slave Φ A 02 Master Φ B 03, Slave B 04 Master Φ C 05, Slave Φ C 06
9	Master Φ A 01, Slave Φ A 02, Slave Φ A 03 Master Φ B 04, Slave Φ B 05, Slave Φ B 06 Master Φ C 07, Slave Φ C 08, Slave Φ C 09
12	M Φ A 01, S Φ A 02, S Φ A 03, S Φ A 04 M Φ B 05, S Φ B 06, S Φ B 07, S Φ B 08 M Φ C 09, S Φ C 10, S Φ C 11, S Φ C 12

Troubleshooting Guide with Phase Sequence

⚠ If the screen of the Sol-Ark inverter shows the error shown below, ensure the phase sequence follows **AB-BC-CA** convention. The message "Grid Phase Wrong" is displayed when the inverter does not detect the correct phase sequence. This situation can cause overloads faults in the system (F18, F26, F34) even with the "LOAD" disconnected and **WILL CAUSE DAMAGE** to the equipment if it is not corrected.

	L1	L2
Inverter (1)	A	B
Inverter (2)	B	C
Inverter (3)	C	A

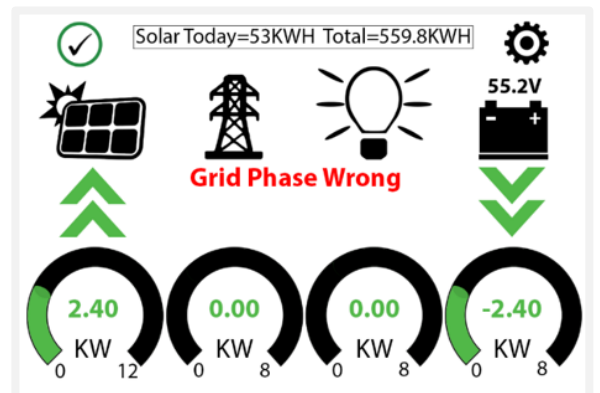

How to find an incorrect phase if prompted "Grid Phase Wrong"?

- Measure L1 GRID of inverter (1) to L2 GRID of inverter (3). Should be 0Vac.
- Measure L2 GRID of inverter (1) to L1 GRID of inverter (2). Should be 0Vac.
- Measure L2 GRID of inverter (2) to L1 GRID of inverter (3). Should be 0Vac.
- Same process should be done for LOAD side.
- Measuring voltage different than 0Vac means the measured lines are not the same phase.
- **Sol-Ark can only receive direct rotation "C" (clockwise).**

Be sure to check both "GRID" and "LOAD" terminal connections; both must be correct. If the error persists you will need to check your AC connection beyond the inverter and you will need to verify that the phases are correctly labeled from your meter.

**In 3 phase systems it is recommended to use a rotational tester (1-2-3, A-B-C).*

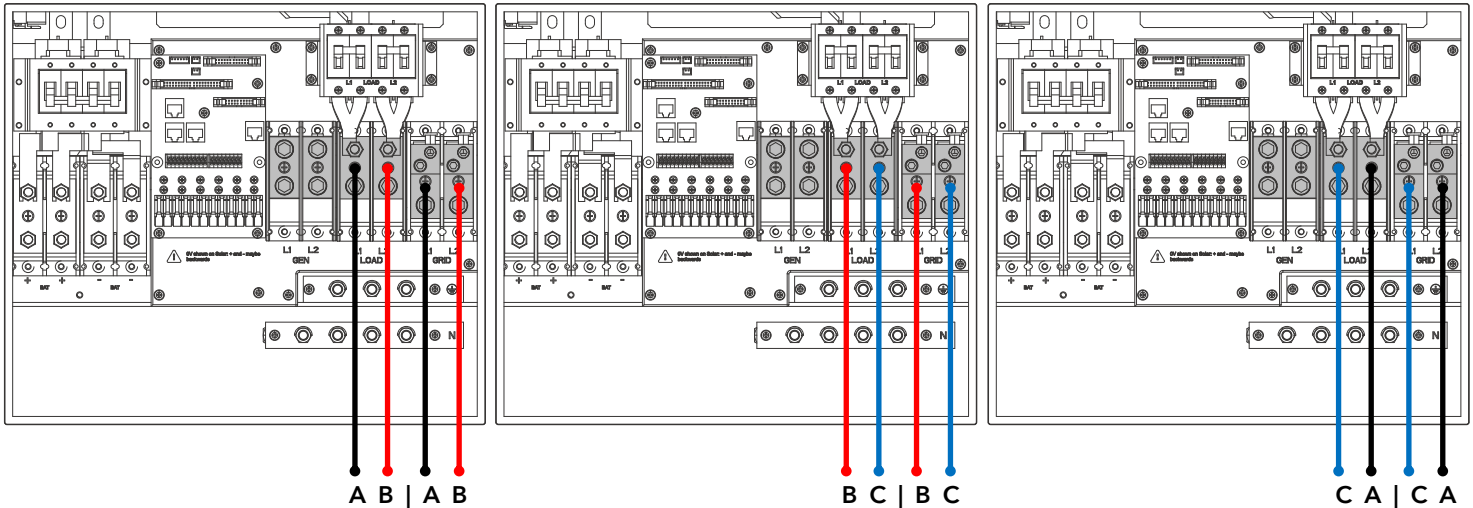

If an inverter goes into a fault state, all other units will stop and follow. The system will automatically self-reboot. If the system faults 5 consecutive times, it will stop completely and it will require a manual restart. See section 2.12 "Power cycle sequence" for detailed instructions.

6. MySolArk: Remote Monitoring



"MySolArk" is a powerful and comprehensive tool designed for remote system monitoring of Sol-Ark inverters and solar systems. This remote monitoring solution offers detailed insights into energy generation and power consumption, allowing users to track system performance with great precision. MySolArk displays all relevant electrical data on easy-to-understand energy generation graphs, providing a comprehensive overview of electrical usage.

Beyond its monitoring capabilities, MySolArk offers users the flexibility to remotely adjust inverter settings, allowing them to seamlessly configure their system from any location. This ensures that users can fine-tune parameters to optimize performance effortlessly. With MySolArk, users can confidently manage their solar systems and inverters to ensure peak performance and efficiency at all times. Visit www.mysolark.com to access the desktop version of MySolArk.

6.1 MySolArk Setup Instructions

Connection to MySolArk through Ethernet

- A. Remove the plastic enclosure of the dongle by pressing the plastic latches with a flat screwdriver as shown in the figure below.
- B. Insert the ethernet cable through the plastic enclosure and connect the cable to the RJ45 port.
- C. Reassemble the dongle housing and plug the dongle into the Sol-Ark, securing it with screws. You will see solid red and green lights after a couple of minutes.
- D. Follow "STEP 1" instructions on the following page in order to create a plant on MySolArk.

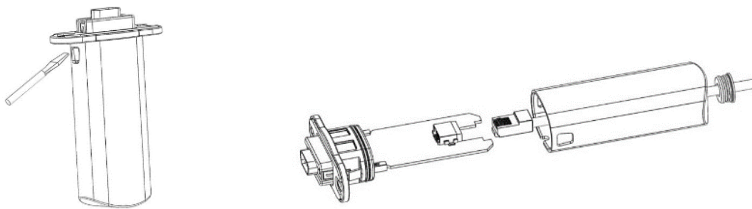

Connection to MySolArk through Wi-Fi

- A. Plug the Wi-Fi dongle into the Sol-Ark DB-9 port.
- B. Use two M4X10 screws to secure the dongle to the port.
- C. Follow "STEP 1" through "STEP 3" in order to:
 - a. Create a plant on the MySolArk monitoring platform.
 - b. Connect the dongle to MySolArk through a Wi-Fi network.

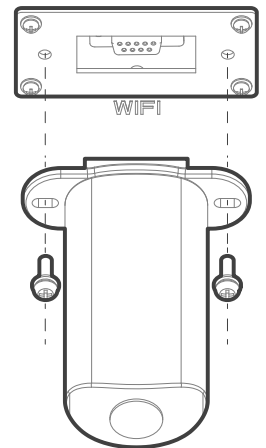

STEP 1: Create a "Plant" on MySolArk

- A. Download and install the "MySolArk" app for android or apple smartphones. QR codes are provided below.



Google Play Store



MySolArk



Apple App Store

B. Create a MySolArk account and login.

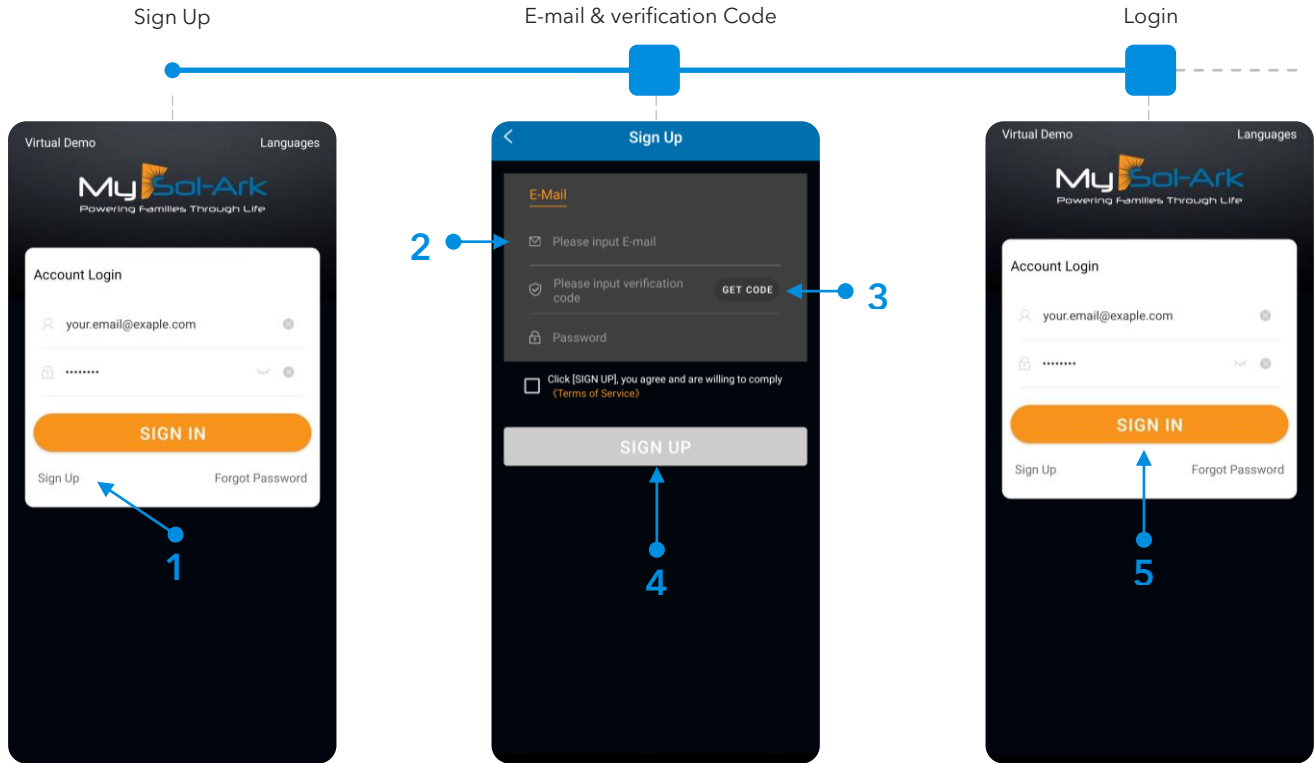

C. Create Plant.

!
For Installers

Installers are advised to first create the plant and configure the system before sharing it with the owner. Once the plant has been created and configured, the installer can share and grant manager permissions to the owner by navigating to "My Plants" → "... " → "Share" → "Add Account". The homeowner must create their own MySolArk account first.

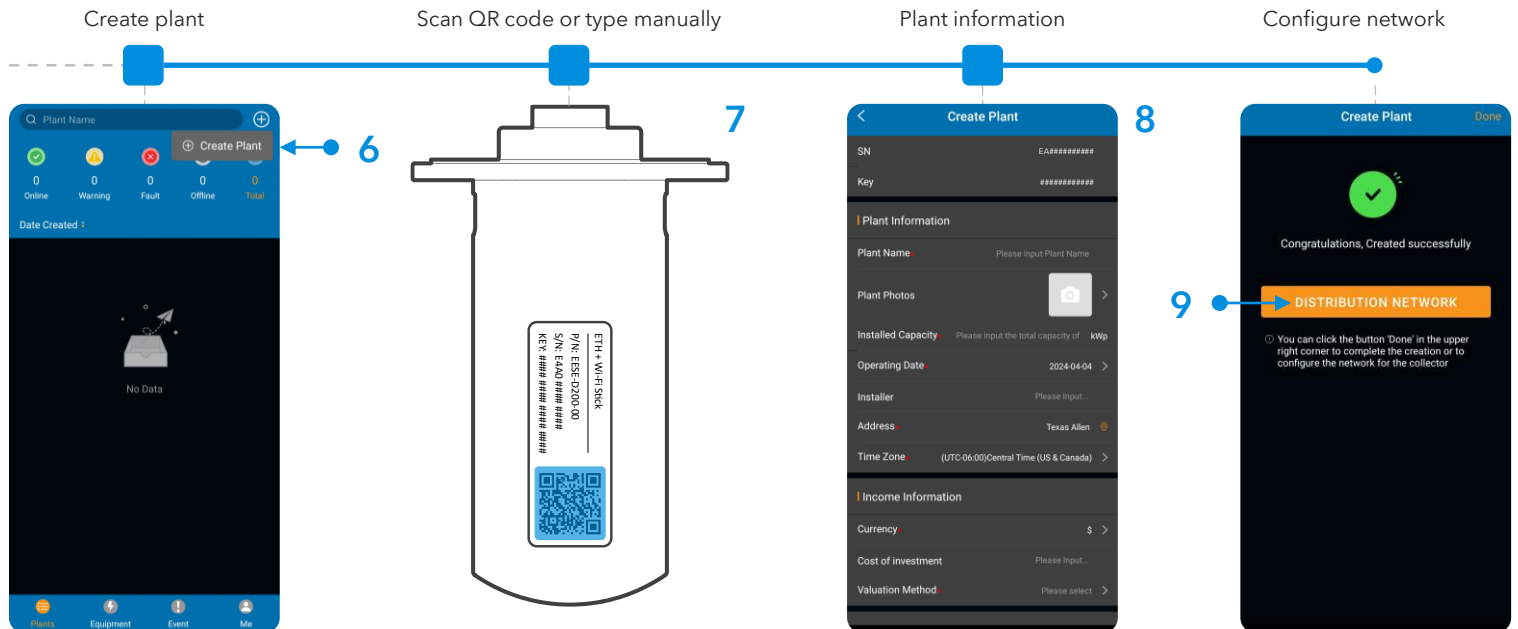

STEP 2: Configure Wi-Fi network through MySolArk

D. Configure Wi-Fi network.

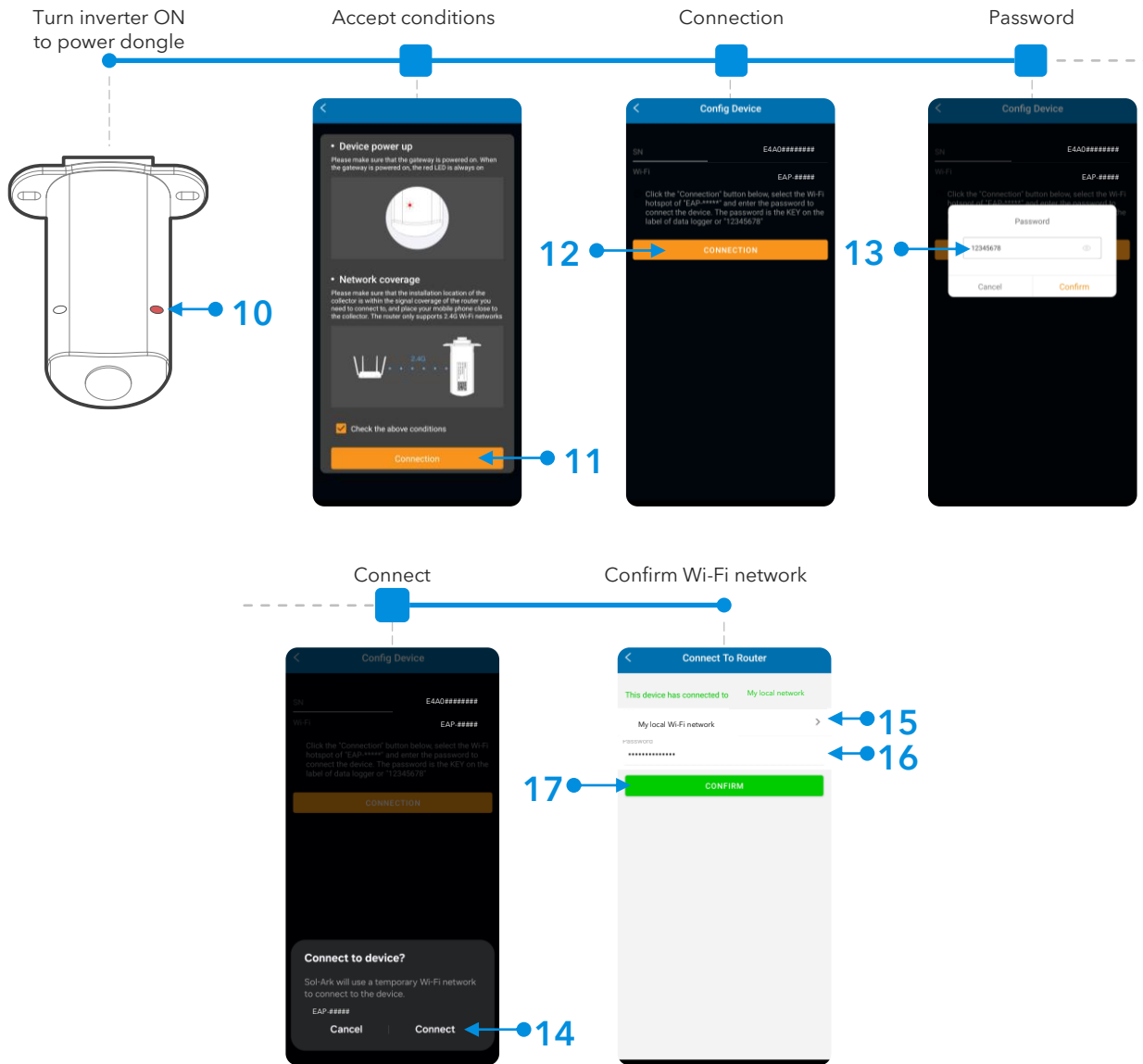

NOTE: The Wi-Fi configuration tool can be accessed at any other time by tapping “Me” at the bottom right corner, then “Tools” and finally “Wi-Fi configuration”. STEP 3 shows an alternative method of connecting the Wi-Fi dongle to a local network through an IP address.

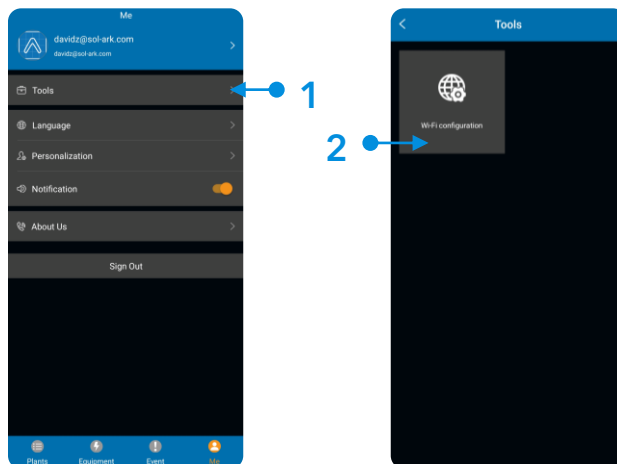

STEP 3 (alternate method): Configure Wi-Fi Network Through an IP Address

- A. An alternative to the "Distribution Network" configuration at the end of step C or the use of the "Wi-Fi configuration" tool, is by configuring a Wi-Fi network through an IP address.
- B. On a Smart Phone or Computer connect to the EAP-##### network. You can do this by going to: **Settings** → **Wi-Fi** → Select the **EAP-#####** network → **Password= 12345678**. The EAP-##### network contains the last 5 digits of the Dongle Serial Number. You can find this number on the label.
- C. A message such as "Connected without internet" will appear once the device is connected to the EAP-#####.

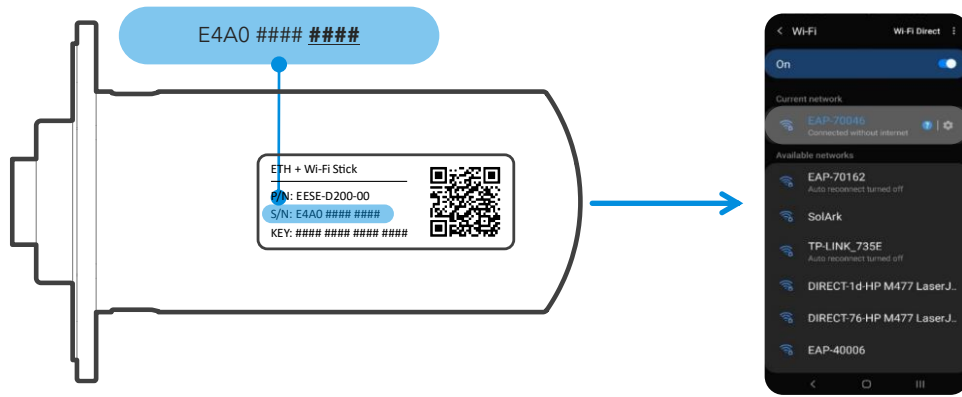

! EAP-##### Network Password= 12345678
NOTE: The Wi-Fi dongle does NOT provide internet access. It needs an external internet provider to connect to. The dongle is compatible with Wi-Fi signal broadcasted at 2.4 GHz (*it is not possible to use 5 GHz*)

- D. Once connected, open an internet browser on that same device such as Safari, Chrome, Firefox, Edge, or any other browser.
- E. On the address bar (http://.....), type the following IP address: **10.10.10.1** as shown in the figure below. If you cannot access the configuration page, try again on a different device.
- F. Scroll down to the "Wlan Connection" section and press the "Scan" button to scan for local Wi-Fi networks.
- G. Nearby Wi-Fi networks will appear. Select the local network you would like to connect to, input your credentials, and tap "Connect".
- H. Once connected, a "Connection Successful" message will appear. Press the "Save" button next to "Scan" to save settings.
- I. Wait a moment (~5 minutes). The dongle will then connect to the Wi-Fi network and will now have access to MySolArk.

! NOTE: **DO NOT** connect to the EAP-##### network as that is the Wi-Fi dongle itself. The device does not provide internet access.

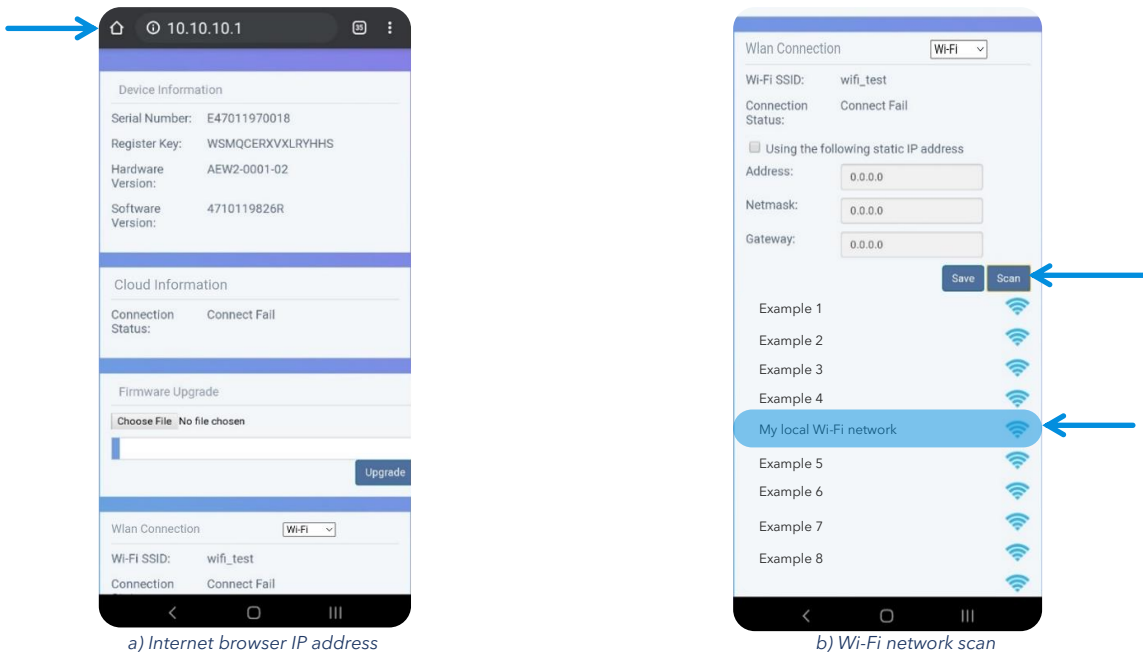

a) Internet browser IP address

b) Wi-Fi network scan

If the connection is a success, you will see the following LED indicators.

- o **SOLID** : Connected and powered by the Sol-Ark inverter.
- o **SOLID** : Connected to the router and to MySolArk.

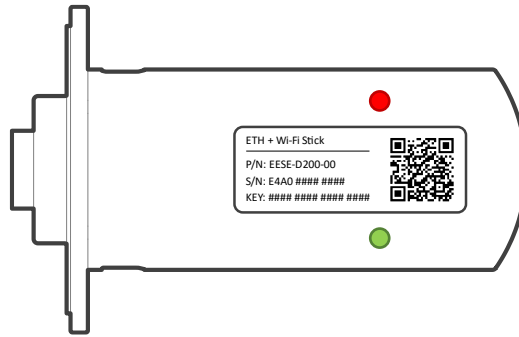

Connecting the through the 10.10.10.1 IP address is only meant to provide internet access to the Wi-Fi dongle. **Users must still create a MySolArk account and must create a Plant.** Visit www.mysolark.com to access the desktop version of MySolArk.

6.2 LED Indicator and troubleshooting

When both the red and green LEDs on the Wi-Fi dongle are consistently illuminated, it signifies normal operation, while flashing indicates data transmission. If this isn't the case, reference the next table of LED indications for troubleshooting and corrective measures.

- RED LED**: Device communication indicator.
- GREEN LED**: MySolArk server communication indicator.

LED	State	Indication
	Initial flashing, then constant illumination	Normal communication.
	Initial flashing but no further illumination	Communication failure. Check proper device connection.
	LED not illuminating	Power supply or device is abnormal. Contact technical support.
	5 second illumination interval	Normal communication.
	1 flash every minute	Router not connected.
	3 flashes every minute	Connected to router but no internet access. Usually, a VPN or firewall issue. Ports 80 and 51100 must be enabled.
	4 flashes every minute	Device communication error. Contact support.
	2 synchronized flashes	Ethernet cable inserted
	3 synchronized flashes	Ethernet cable disconnected

7. Wiring Diagrams



The following diagrams are general use cases. Installers are reminded that adherence to local electrical codes and regulations is mandatory. While these diagrams offer general guidance, they may not encompass all variations and specifics required by local codes. Consult with relevant authorities and ensure compliance before proceeding with any installation. The diagrams presented herein are not exhaustive and should not be relied upon solely for permitting or warranty verification. Installers are encouraged to exercise caution, seek professional advice when necessary, and undertake installations with due diligence and in accordance with established electrical standards and regulations.

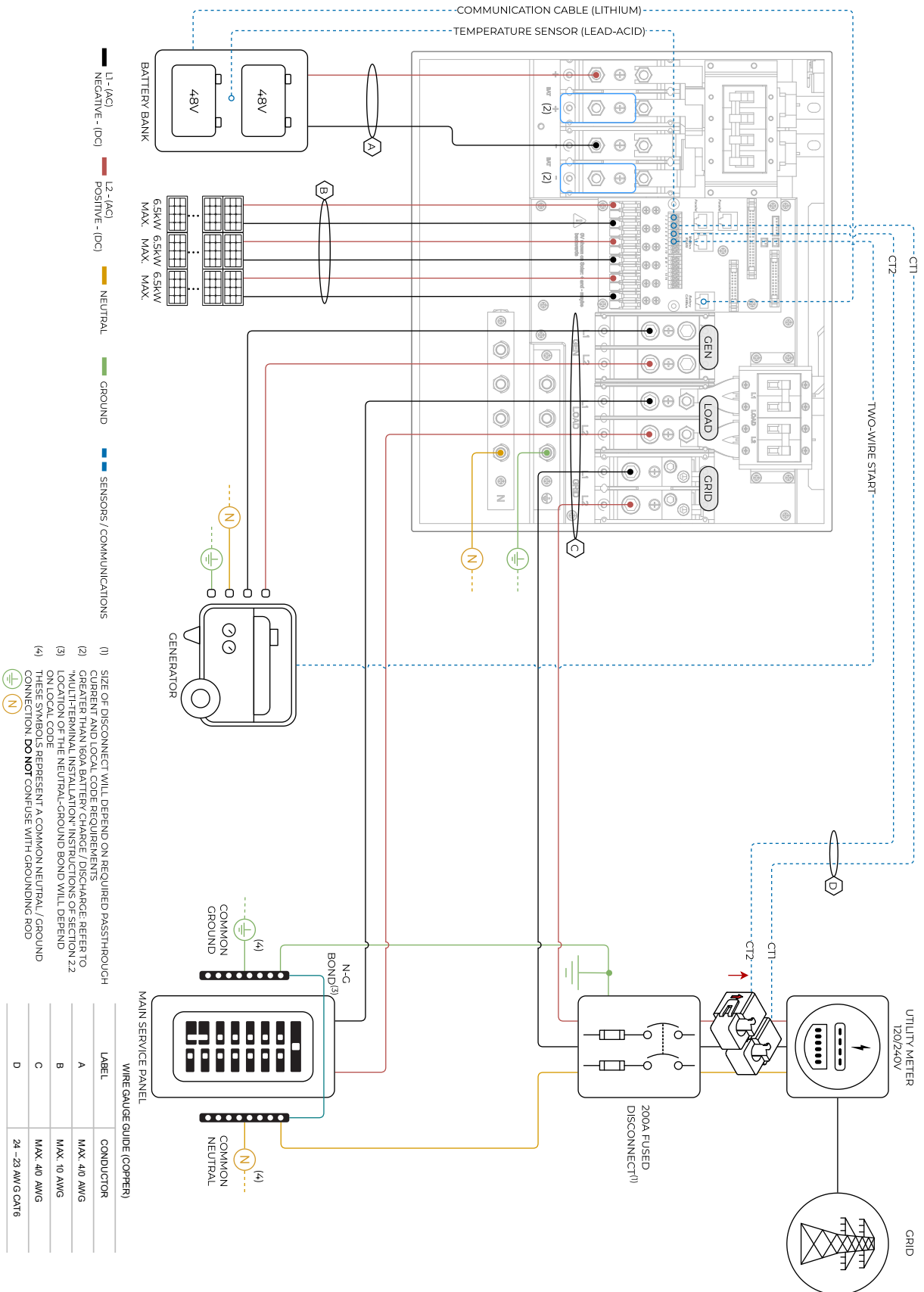

Sol-Ark 15K-2P-N
Standard Wiring Diagram

Diagram 01

Sol-Ark 15K-2P-N
Standard Wiring Diagram - Line Side Tap

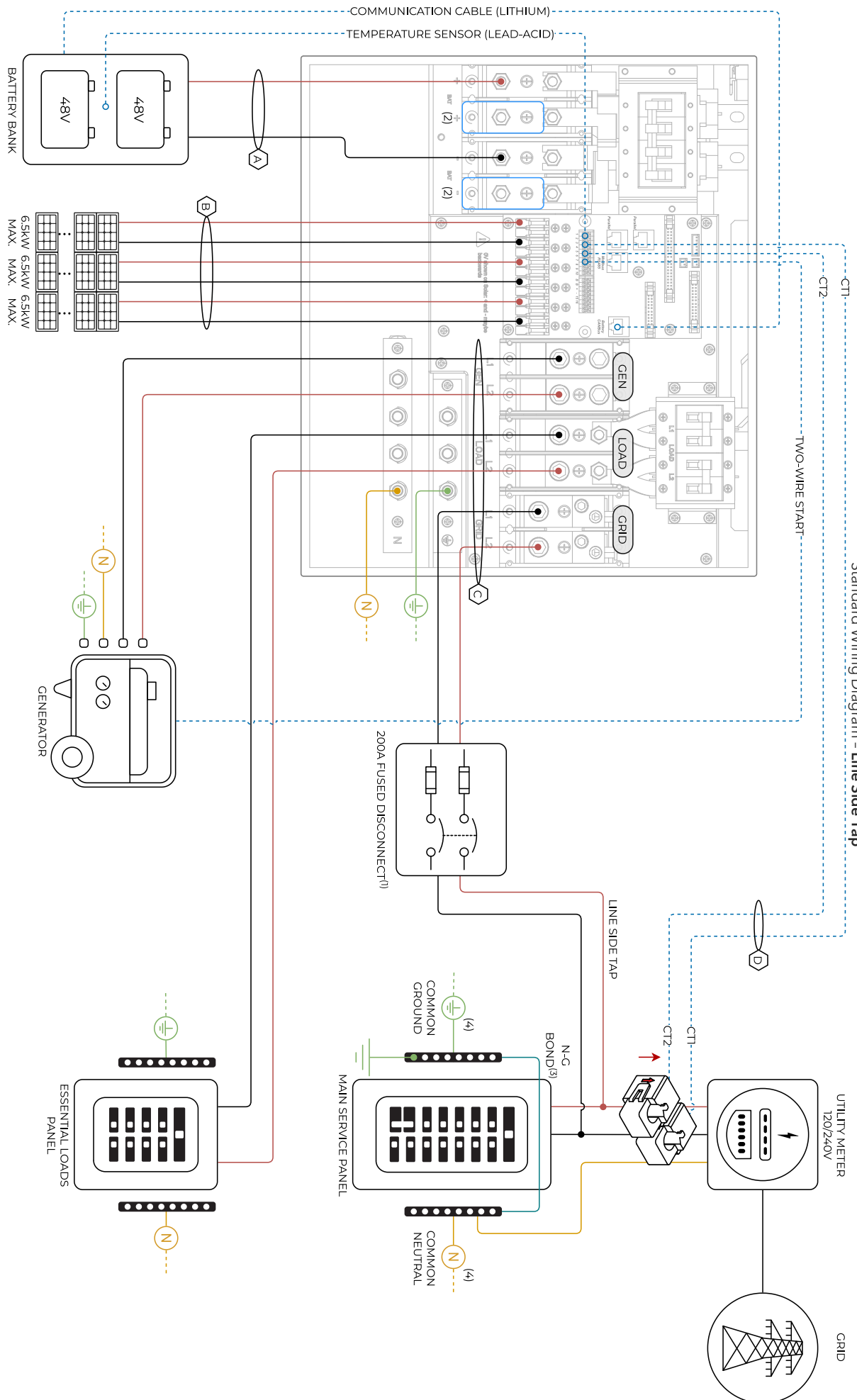

- 1- (AC) L1 - (AC) NEGATIVE - (DC)
- 2- (AC) L2 - (AC) POSITIVE - (DC)
- NEUTRAL
- GROUND
- SENSORS / COMMUNICATIONS

- (1) SIZE OF DISCONNECT WILL DEPEND ON REQUIRED PASSTHROUGH CURRENT AND LOCAL CODE REQUIREMENTS
- (2) GREATER THAN 160A BATTERY CHARGE / DISCHARGE; REFER TO "MULTI-TERMINAL INSTALLATION" INSTRUCTIONS OF SECTION 2.2
- (3) LOCATION OF THE NEUTRAL-GROUND BOND WILL DEPEND ON LOCAL CODE
- (4) THESE SYMBOLS REPRESENT A COMMON NEUTRAL / GROUND CONNECTION. **DO NOT** CONFUSE WITH GROUNDING ROD

WIRE GAUGE GUIDE (COPPER)	
LABEL	CONDUCTOR
A	MAX. 4/0 AWG
B	MAX. 10 AWG
C	MAX. 4/0 AWG
D	24 -23 AWG CAT6

Diagram 02

Sol-Ark 15K-2P-N Standard Wiring Diagram - AC Coupling in GEN

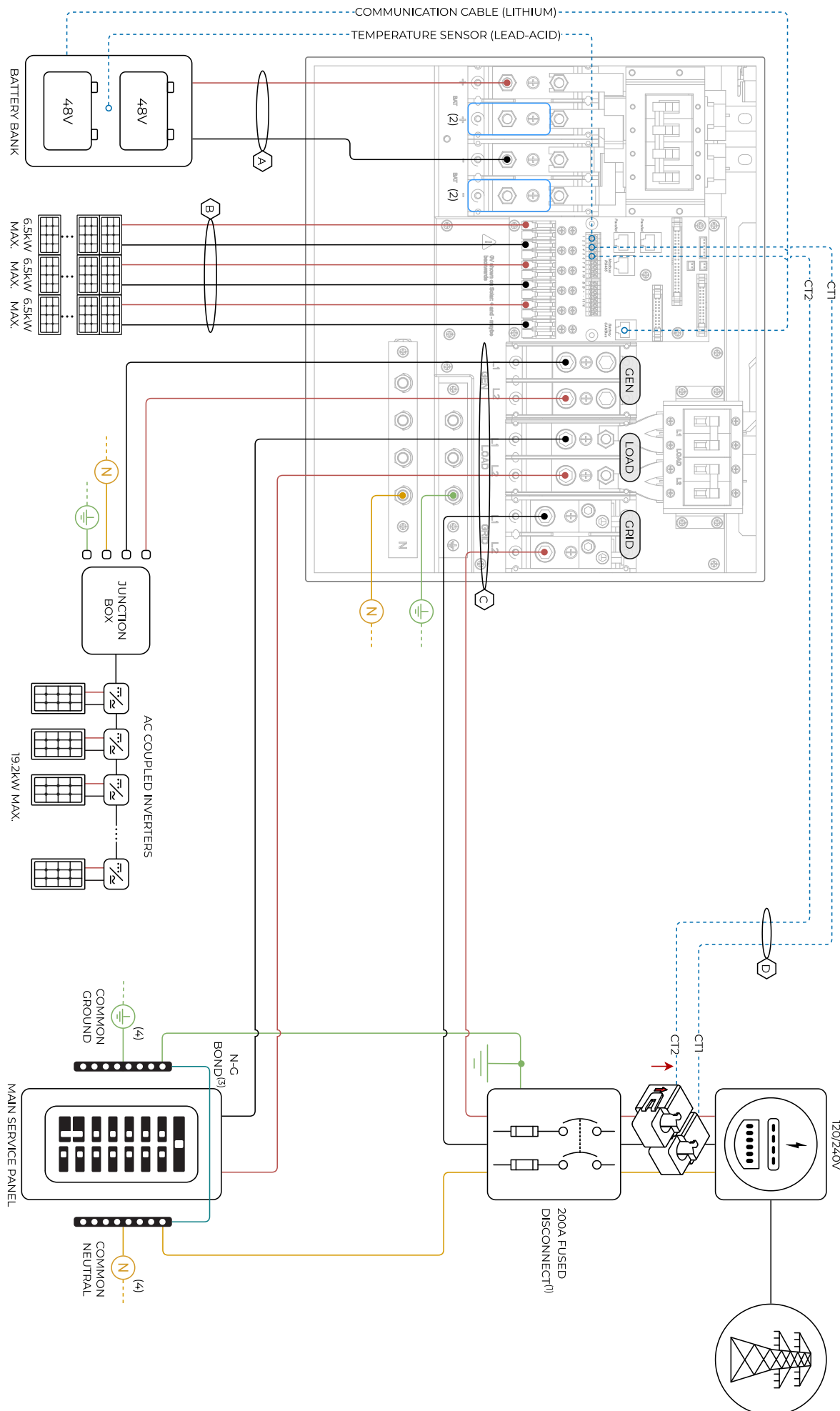

- L1 - (AC) NEGATIVE - (DC)
- L2 - (AC) POSITIVE - (DC)
- NEUTRAL
- GROUND
- SENSORS / COMMUNICATIONS

- (1) SIZE OF DISCONNECT WILL DEPEND ON REQUIRED PASSTHROUGH CURRENT AND LOCAL CODE REQUIREMENTS
- (2) GREATER THAN 160A BATTERY CHARGE / DISCHARGE: REFER TO "MULTI-TERMINAL INSTALLATION" INSTRUCTIONS OF SECTION 2.2
- (3) LOCATION OF THE NEUTRAL-GROUND BOND WILL DEPEND ON LOCAL CODE
- (4) THESE SYMBOLS REPRESENT A COMMON NEUTRAL / GROUND CONNECTION. **DO NOT** CONFUSE WITH GROUNDING ROD

WIRE GAUGE GUIDE (COPPER)	
LABEL	CONDUCTOR
A	MAX. 4/0 AWG
B	MAX. 10 AWG
C	MAX. 4/0 AWG
D	24 -23 AWG CAT6

Diagram 03

Sol-Ark 15K-2P-N Standard Wiring Diagram - AC Coupling in LOAD

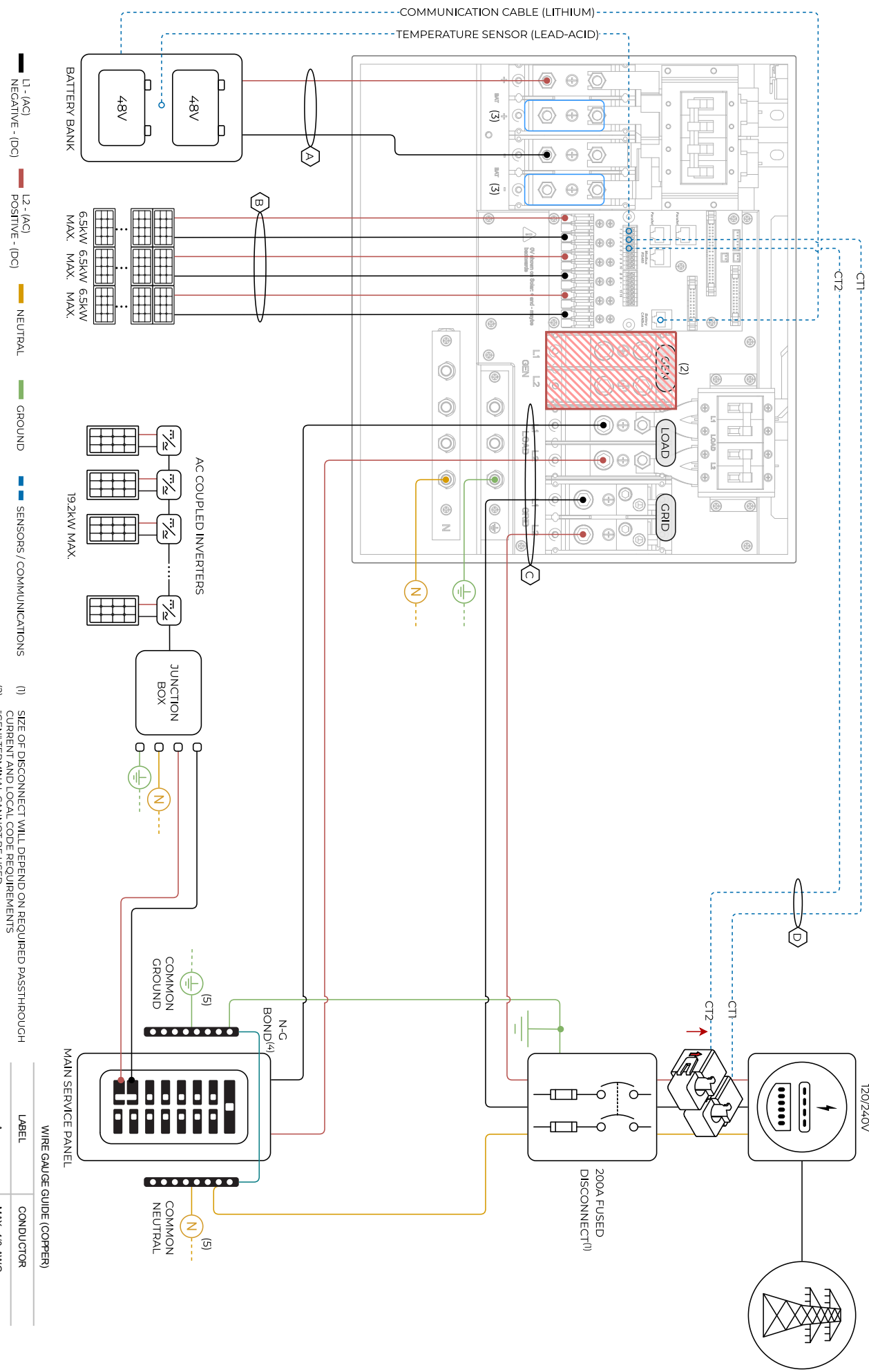

- L1 - (AC) POSITIVE - (DC)
- L2 - (AC) NEGATIVE - (DC)
- NEUTRAL
- GROUND
- SENSORS / COMMUNICATIONS

- (1) SIZE OF DISCONNECT WILL DEPEND ON REQUIRED PASSTHROUGH CURRENT AND LOCAL CODE REQUIREMENTS
- (2) "GEN" TERMINAL CANNOT BE USED
- (3) "MULTITERMINAL INSTALLATION" INSTRUCTIONS OF SECTION 2.2 ON LOCAL CODE
- (4) LOCATION OF THE NEUTRAL-GROUND BOND WILL DEPEND ON LOCAL CODE
- (5) THESE SYMBOLS REPRESENT A COMMON NEUTRAL / GROUND CONNECTION. **DO NOT** CONFUSE WITH GROUNDING ROD

WIRE GAUGE GUIDE (COPPER)	
LABEL	CONDUCTOR
A	MAX. 4/0 AWG
B	MAX. 10 AWG
C	MAX. 4/0 AWG
D	24 - 23 AWG CAT6

Diagram 04

Sol-Ark 15K-2P-N Standard Wiring Diagram - Whole-Home Generator

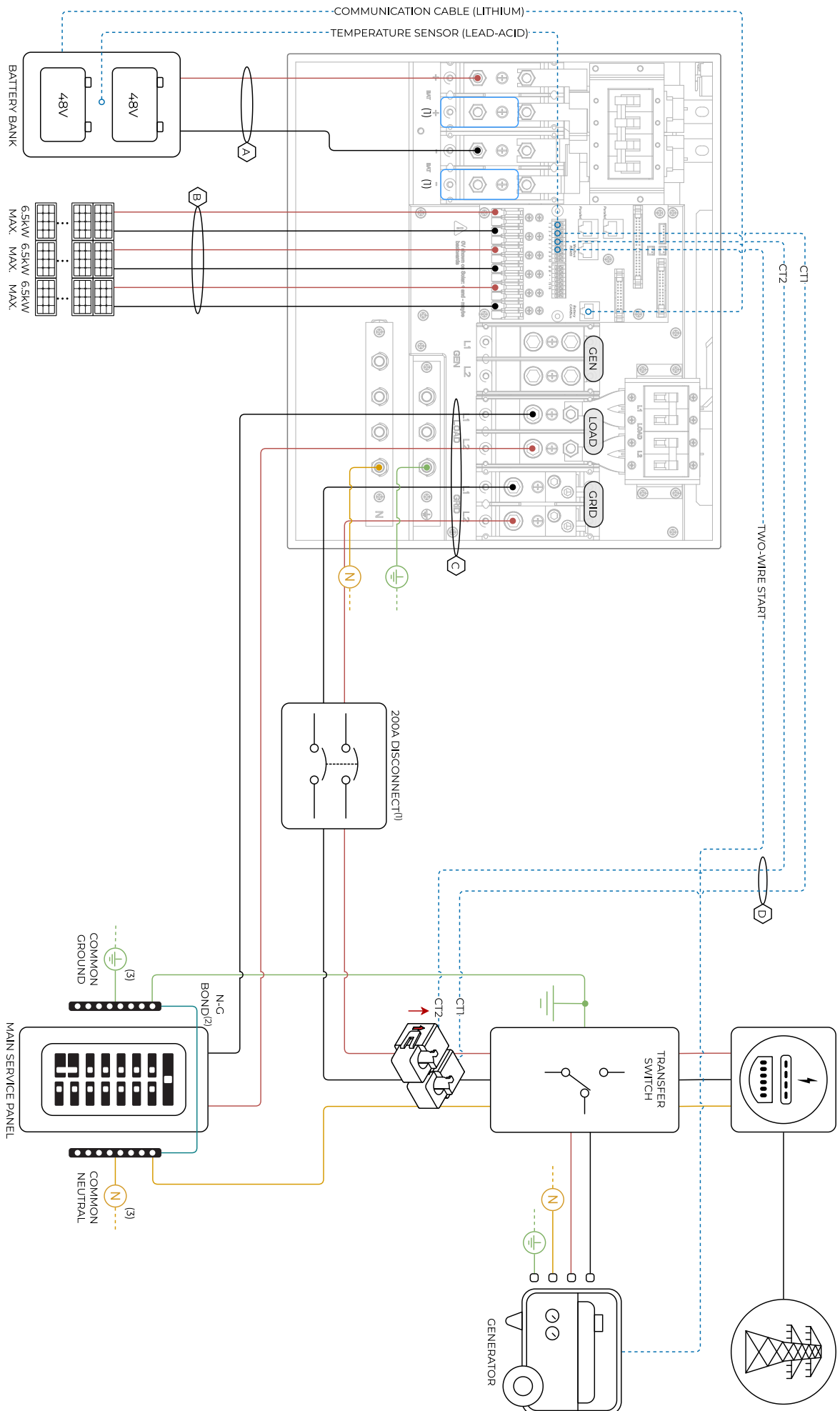

- L1 - (AC) NEGATIVE - (DC)
- L2 - (AC) POSITIVE - (DC)
- NEUTRAL
- GROUND
- SENSORS / COMMUNICATIONS

- (1) GREATER THAN 160A BATTERY CHARGE / DISCHARGE: REFER TO "MULTI-TERMINAL INSTALLATION" INSTRUCTIONS OF SECTION 2.2
- (2) LOCATION OF THE NEUTRAL-GROUND BOND WILL DEPEND ON LOCAL CODE
- (3) THESE SYMBOLS REPRESENT A COMMON NEUTRAL / GROUND CONNECTION. **DO NOT** CONFUSE WITH GROUNDING ROD

WIRE GAUGE GUIDE (COPPER)

LABEL	CONDUCTOR
A	MAX. 4/0 AWG
B	MAX. 10 AWG
C	MAX. 4/0 AWG
D	24 - 23 AWG CAT6

Diagram 05

Sol-Ark 15K-2P-N
Standard Wiring Diagram - Off Grid

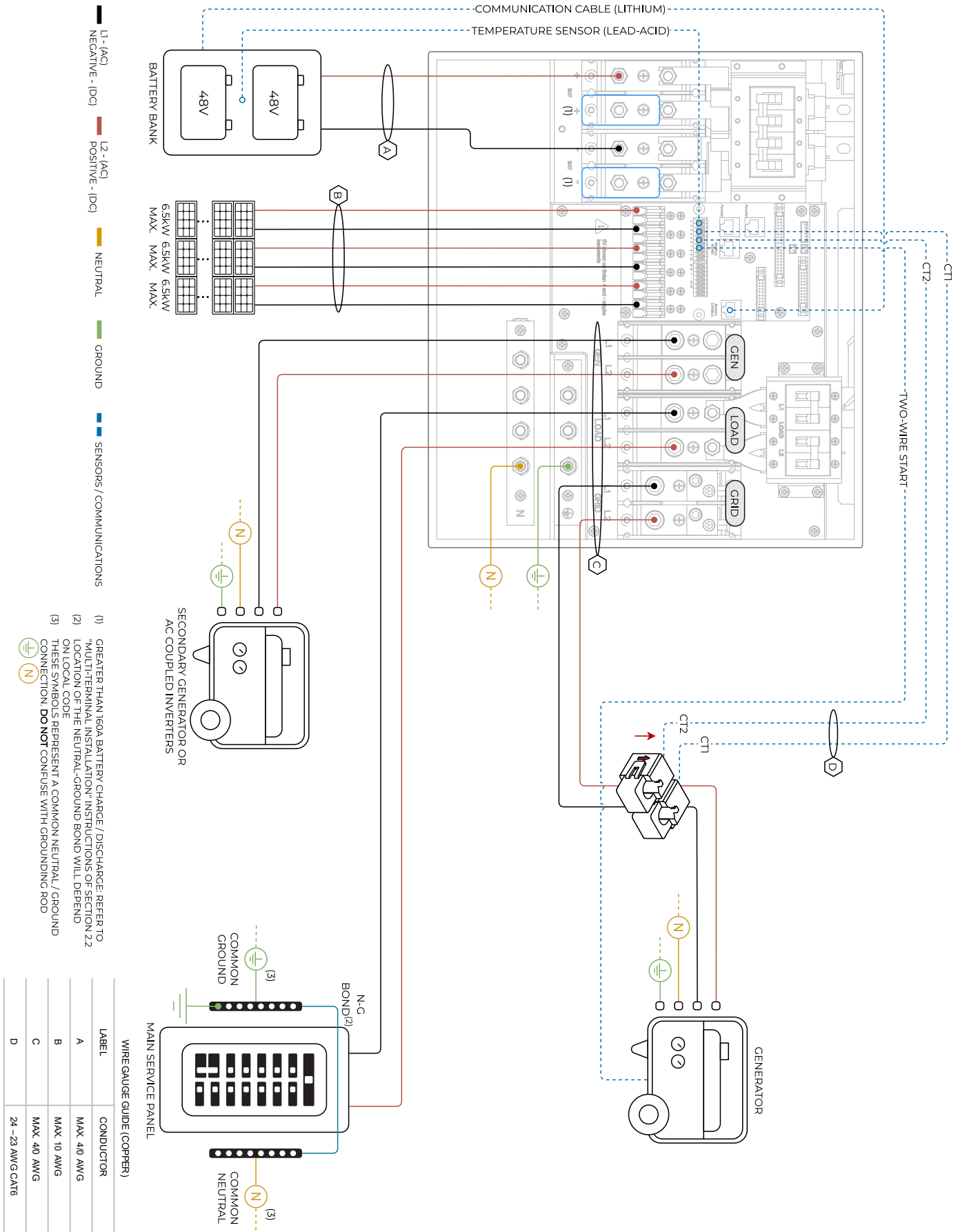

Diagram 06

Standard Wiring Diagram – Bypass Transfer Switch

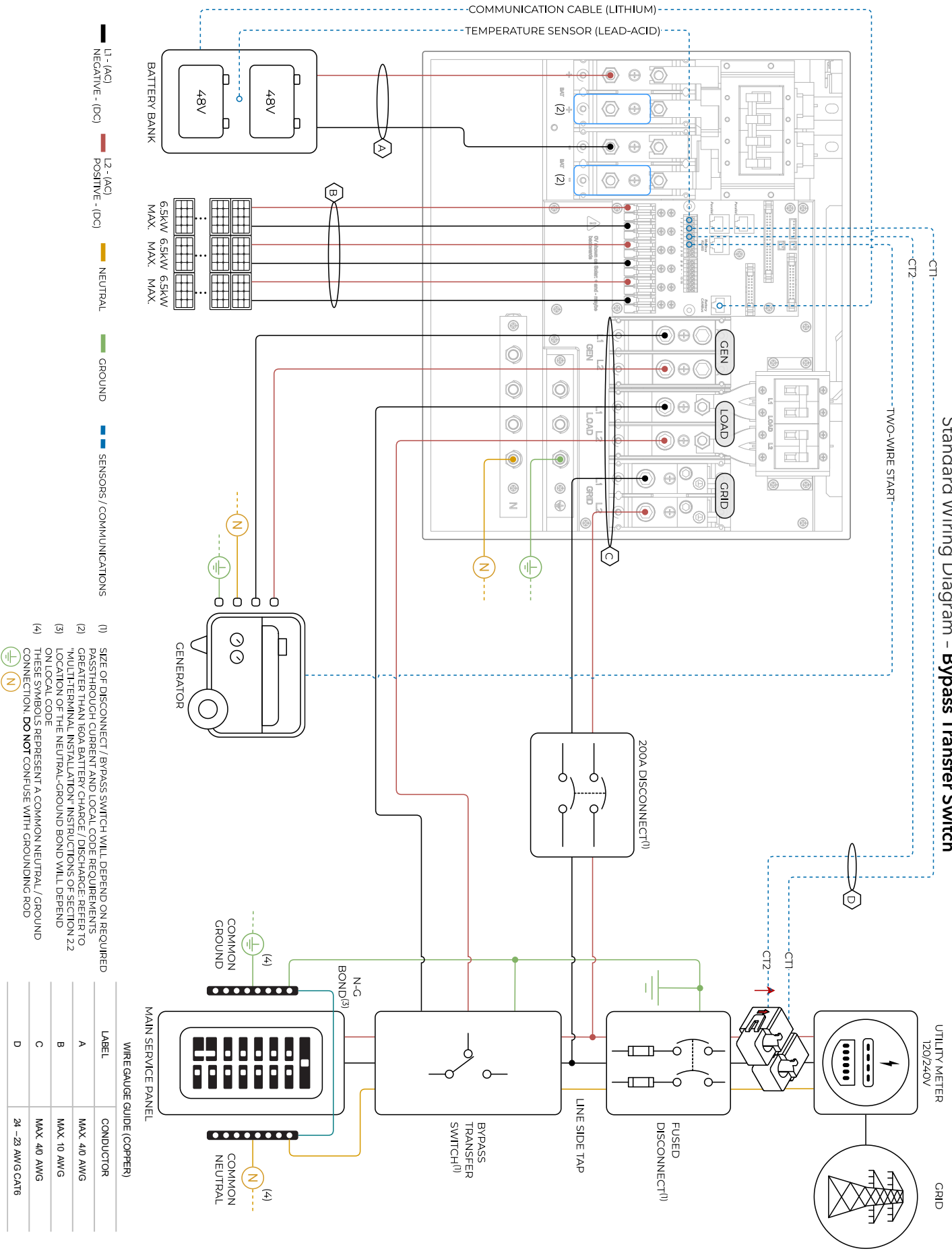
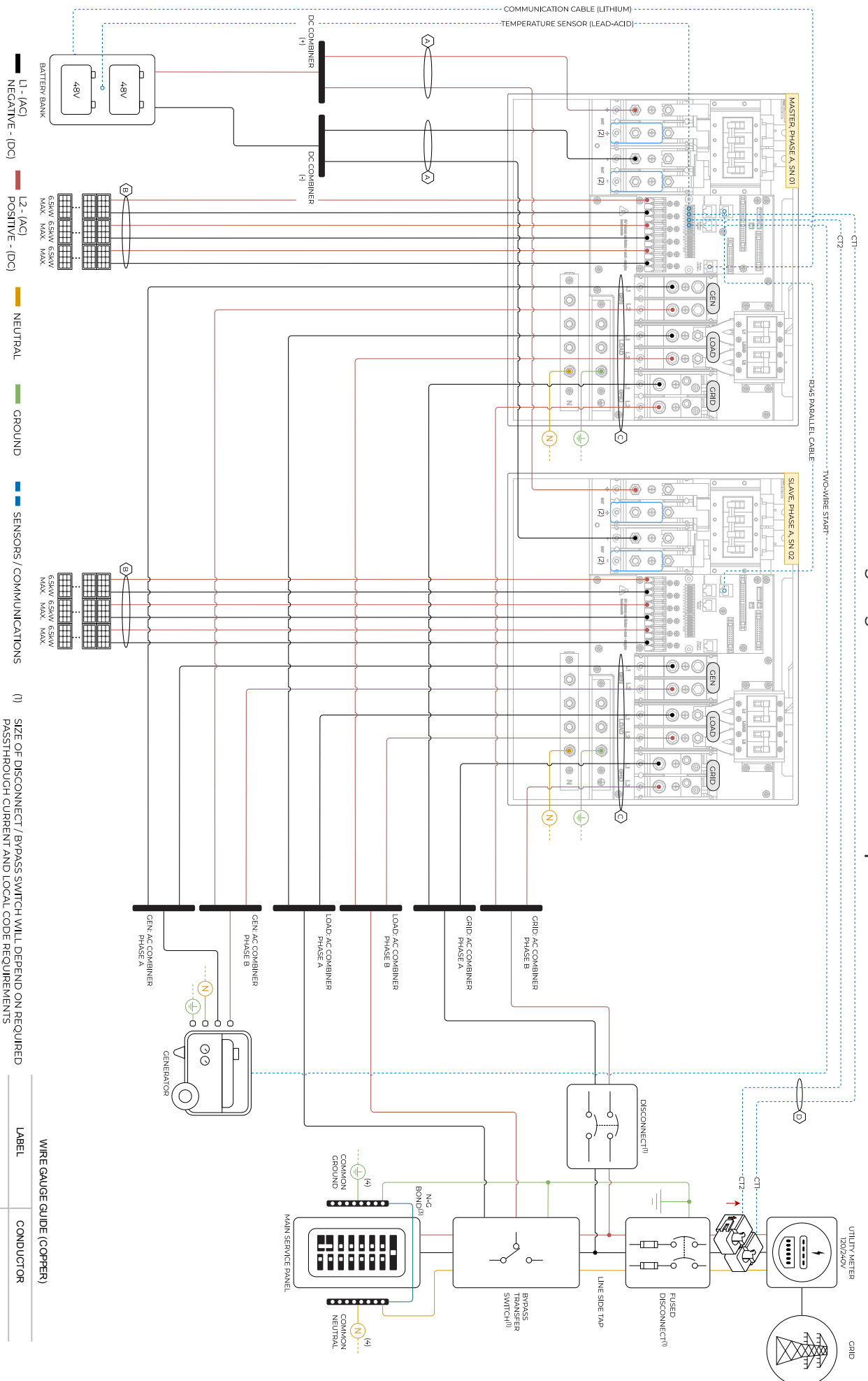

Diagram 07

Standard Wiring Diagram – 2 Parallel Inverters | 120/240V

Sol-Ark 15K-2P-N



— L1 - (AC)
— NEGATIVE - (DC)
— L2 - (AC)
— POSITIVE - (DC)

— NEUTRAL
— GROUND
— SENSORS / COMMUNICATIONS

- (1) SIZE OF DISCONNECT / BYPASS SWITCH WILL DEPEND ON REQUIRED PASSTHROUGH CURRENT AND LOCAL CODE REQUIREMENTS
- (2) GREATER THAN 160A BATTERY CHARGE / DISCHARGE: REFER TO "MULTI-TERMINAL INSTALLATION" INSTRUCTIONS OF SECTION 2.2
- (3) LOCATION OF THE NEUTRAL-GROUND BOND WILL DEPEND ON LOCAL CODE
- (4) THESE SYMBOLS REPRESENT A COMMON NEUTRAL / GROUND CONNECTION. **DO NOT** CONFUSE WITH GROUNDING ROD

WIRE GAUGE GUIDE (COPPER)	
LABEL	CONDUCTOR
A	MAX. 4/0 AWG
B	MAX. 10 AWG
C	MAX. 4/0 AWG
D	24 - 23 AWG CAT6

Diagram 08

1 Before powering up Parallel System installs, please see section 5 "Parallel Systems"

SolarK 15K-2P-N Standard Wiring Diagram – 3 Parallel Inverters | 120/240V

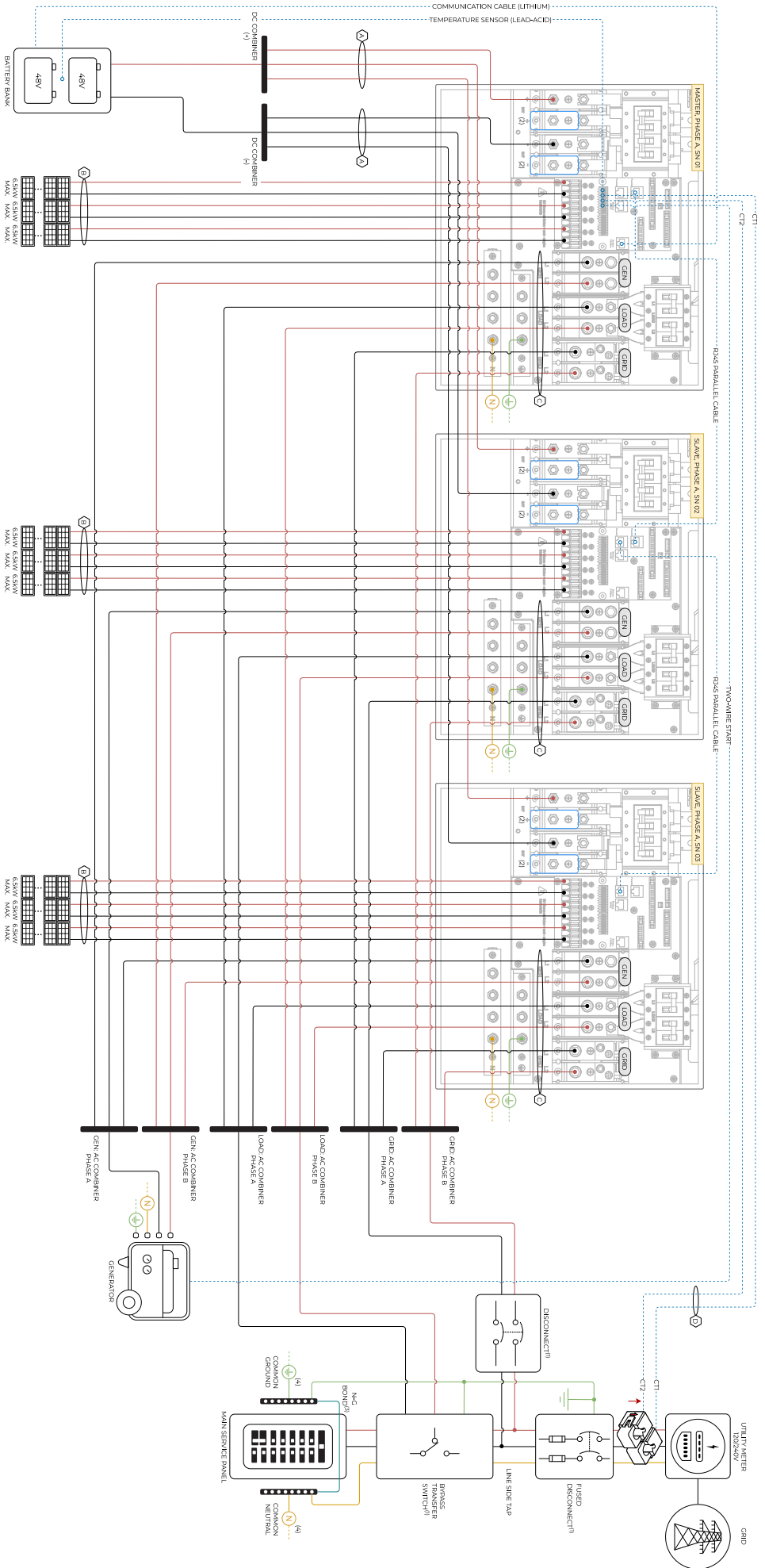

- L1 - (AC)
- NEGATIVE - (DC)
- L2 - (AC)
- POSITIVE - (DC)
- NEUTRAL
- GROUND
- SENSORS / COMMUNICATIONS

- (1) SIZE OF DISCONNECT / BYPASS SWITCH WILL DEPEND ON REQUIRED PASSTHROUGH CURRENT AND LOCAL CODE REQUIREMENTS
- (2) GREATER THAN 100A BATTERY CHARGE / DISCHARGE REFER TO "MULTITERMINAL INSTALLATION" INSTRUCTIONS OF SECTION 2.2 ON LOCAL CODE
- (3) LOCATION OF THE NEUTRAL-GROUND BOND WILL DEPEND ON LOCAL CODE
- (4) THESE SYMBOLS REPRESENT A COMMON NEUTRAL / GROUND CONNECTION. DO NOT CONFUSE WITH GROUNDING ROD

WIRE GAUGE GUIDE (COPPER)	
LABEL	CONDUCTOR
A	MAX. 4/0 AWG
B	MAX. 1/0 AWG
C	MAX. 4/0 AWG
D	24 - 23 AWG CAT6

1 Before powering up Parallel System installs, please see section 5 "Parallel Systems"

Diagram 09

Sol-Ark 15K-2P-N Standard Wiring Diagram – 2 Parallel Inverters | 120/208V

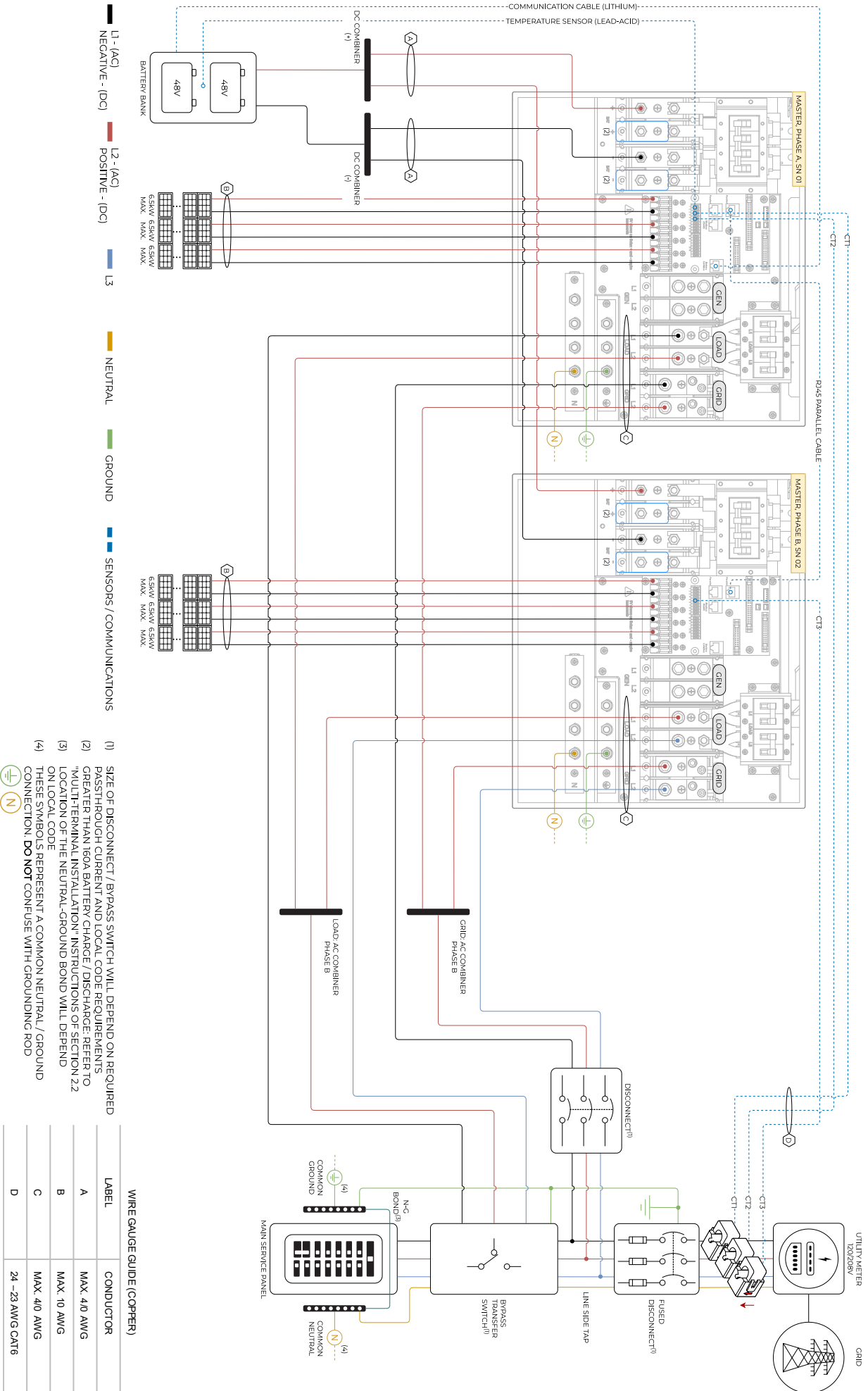
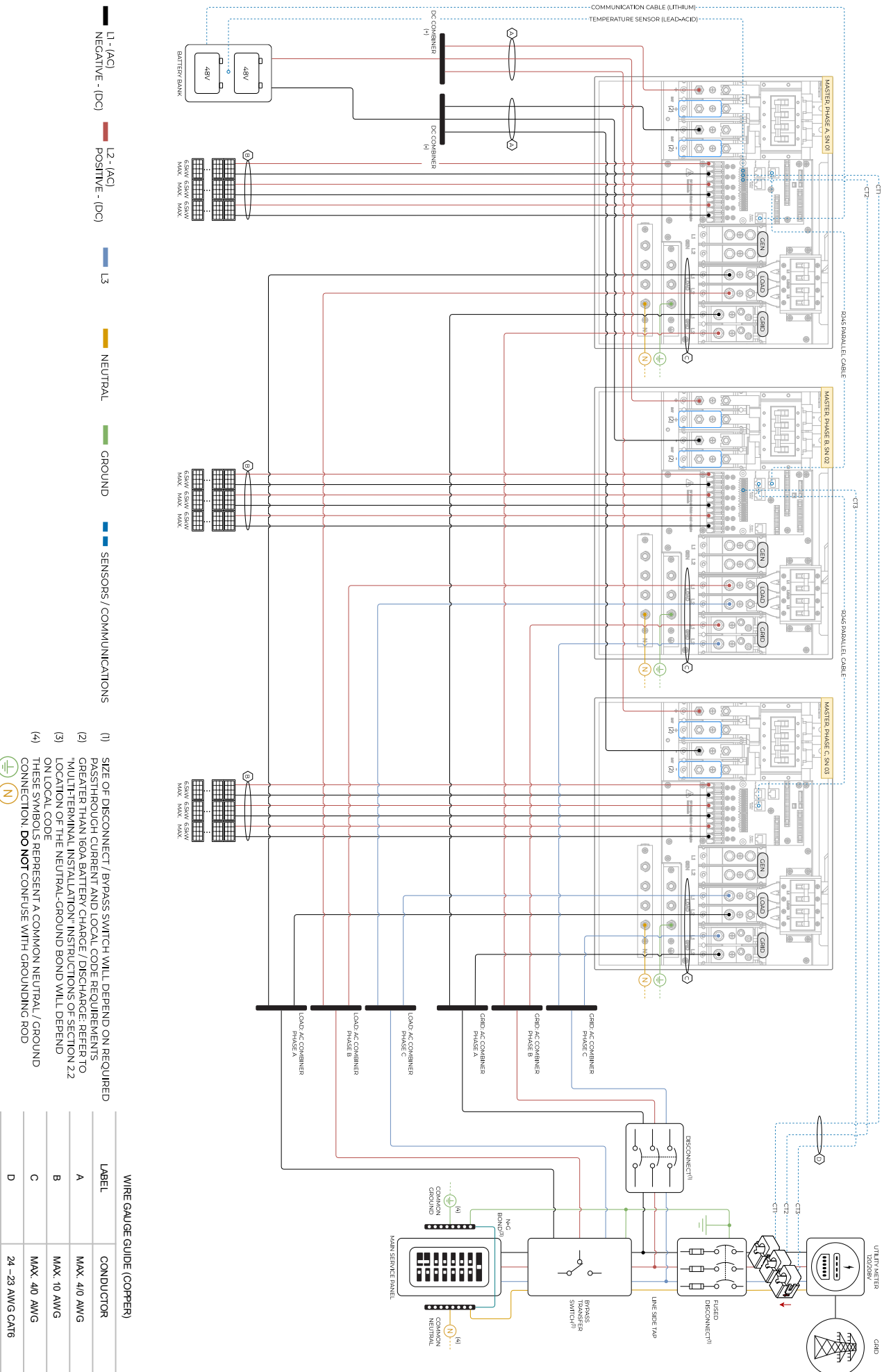

Diagram 10

1 Before powering up Parallel System installs, please see section 5 "Parallel Systems"

Sol-Ark 15K-2P-N Standard Wiring Diagram – 3 Parallel Inverters | 120/208V



- L1 - (AC) NEGATIVE - (DC)
- L2 - (AC) POSITIVE - (DC)
- L3
- NEUTRAL
- GROUND
- SENSORS / COMMUNICATIONS

- (1) SIZE OF DISCONNECT / BYPASS SWITCH WILL DEPEND ON REQUIRED PASSES THROUGH CIRCUIT AND LOCAL CODE REQUIREMENTS
- (2) GREATER THAN 100A BATTERY CHARGE / DISCHARGE: REFER TO "MULTI-TERMINAL INSTALLATION" INSTRUCTIONS OF SECTION 2.2 ON LOCAL CODE
- (3) THESE SYMBOLS REPRESENT A COMMON NEUTRAL / GROUND CONNECTION. **DO NOT** CONFUSE WITH GROUNDING ROD

1 Before powering up Parallel System installs, please see section 5 "Parallel Systems"

Diagram 11

8. Troubleshooting Guide

LCD is not powering on

- Check all connections - at least one of the following power sources is required: PV/Grid/Battery
- Try pressing the power button, touchscreen, or navigation buttons

Panels are connected, but "DC" LED indicator is not on

- Minimum starting voltage is 125V. Voltage must be above 125V and below 500V
- Wrong polarity. Check string polarity on MPPT
- PV DC disconnect is not on the ON position

Panels are not producing

- Check for proper wiring on all solar panel connections
- Turn PV disconnect "ON"
- Check that the PV input voltage is not greater than 500V
- If the system measures 0V even when PV DC disconnect is ON, polarity might be wrong. Check PV polarity

Panels are not producing much power

- PV Wire Strip Length: 5/8". Your batteries are charged and is limited to house loads; you can test Grid Sell to verify.

The system does not keep batteries charged

- Verify there is proper communication between the Sol-Ark and the battery. : ⚙️ → *Li-Batt Info*
- Verify proper Charge and Voltage settings according to battery manufacturer and battery bank arrangement

Auto Gen-Start is not working

- Make sure the generator has a compatible Two-Wire
- Verify adequate connection to the Sol-Ark auto-start input pins

"Normal" LED indicator is not on

- Sol-Ark is in pass-through-only mode, only a Grid connection
- Not fully energized (DC Solar panels AND Grid or just batteries)
- In alarm state.
- Sol-Ark is not working correctly (Call technical support +1 (972) 575-8875 Ext. 2)

The "Alarm" LED indicator is on

- Check the system alarms menu to identify the alarm

Grid HM value is negative when it should be positive (only applies in Limited to Home mode)

- Limiter Sensors are backwards, L1/L2 sensors are swapped, or incorrectly wired. Execute the "Auto Learn Home Limit Sensors" command described in section 2.9 "Limit Sensors, Automatic CT Limit Sensors Configuration"

AC Overload Fault or Bus Unbalance Fault

- Check Transfer Switch/Subpanel wiring
- Check for large loads that consume more than the inverter rating

The system connects to grid and quickly disconnects

- Verify Neutral wire connection (0Vac referenced to GND)
- Check the programmed frequency, and verify the Sol-Ark measures 120V between L and N
- If the system is overloading: verify that proper phase sequence between "GRID" and "LOAD" terminals

DC Overload Fault

- Check PV voltage. Ensure no more than 500V
- Make sure you have not wired more than two (2) solar strings in parallel per MPPT

System is beeping

- Check the System Alarms menu to see which alarm has been triggered. Most alarms will self-reset
- Do a Power Cycle as described in section 2.12 "Power Cycle Sequence"

Battery cable sparks when connected

- If applicable, flip the built-in breakers of the battery bank before connecting or disconnecting batteries

Battery symbol on the home screen is red

- The battery is below the empty voltage
- Battery is over-voltage

Battery symbol on the home screen is yellow

- The battery is low, or the charge/discharge current is close to the programmed limit

Grid symbol on the home screen is yellow

- Grid parameters are out of specified operating range
- There is a grid outage and there is no voltage on the "GRID" terminal
- System is Off-Grid

System has restarted

- Occurs when the system has overloaded, battery voltage has surpassed 63V
- There was a Software update

Batteries were connected backwards

-  System will be damaged, and warranty will be lost

Why is the LCD screen still on when the power button is off?

- Occurs when the power button is in the "OFF" position
- Occurs when the system is not fully energized: PV or Grid only

The Batt SOC% is not reaching 100%

- The Sol-Ark might be in the calibration phase and estimating the battery SOC. We suggest waiting three full days to let the unit go through the 4-stage charging curve to converge to an accurate %
- If the suggestion above does not work, you can re-adjust the battery capacity under "Battery Setup" → "Batt Capacity" to restart the calibration process

Generator setup is reading 0Hz

- Generator is operating at a frequency outside the permissible range. Select " General Standard " grid mode. Widen the frequency range to 55Hz-65Hz as described in section 2.5 "Integrating a Generator"

Color Touchscreen is Frozen

- Press and hold the escape button [◀] for 7-10 seconds
- Perform a power cycle sequence in case the above suggestion does not work. See section 2.12 "Power Cycle Sequence"

Grid Phase Wrong

-  If the Sol-Ark screen shows a "Grid Phase Wrong" message, it means there is a phasing issue in the wiring. If left unchecked it may cause overload faults and **DAMAGE**. See section 5.3 "Three-Phase Systems"

8.1 Sol-Ark Error codes

FAULT	INSTRUCTION	COMMON CAUSE / REMEDY
F1	DC_Inversed_Failure	If you have parallel systems and turn one system off, you will get this notification. NOT a fault.
F8	GFDI_Relay_Failure	Check for continuity on the inverter's neutral and ground. Ensure there is only ONE neutral-to-ground bond in the system. Current Leakage from inverter AC output to Ground, check Ground and neutral are connected at the main panel.
F13	Grid_Mode_change	It can happen when not using batteries or if Grid Input settings are changed. This is a notification, NOT a fault. If you switch from No Batt to Battery mode, power the system down completely to restart.
F15	AC_OverCurr_Failure	It is usually caused by Loads too large for the inverter. If Off-Grid, the battery discharge Amps are programmed too low. Overloads can result in F15, F18, F20, or F26.
F16	GFCI_Failure	Ground fault. Check PV+ or PV- wiring (which must be ungrounded). Exposed PV conductors + rain can also cause. Check that the neutral line and Ground are not double-bonded (common with portable generators).
F18	Tz_AC_OverCurr_Fault	Overloaded the Load Output (reduce loads) or overloaded a generator (reduce Gen Start A). Wiring Short on the AC Side can also cause this error. Overloads can result in F15, F18, F20, or F26.
F20	Tz_Dc_OverCurr_Fault	It is typically caused by DC current from the battery that is too large (ex: 4 Ton AC Unit) or too much PV current (3 or more strings in parallel). Overloads can result in F15, F18, F20, or F26.
F22	Tz_EmergStop_Fault	Initiated Emergency Stop; see sensor pinout table.
F24	DC_Insulation_Fault	An exposed PV conductor combined with moisture is faulting (can cause F16, F24, and F26).
F25	DC_Feedback_Fault	No battery connection to the Inverter and Activate Battery is enabled. Disable Activate Battery in settings while no battery is connected.
F26	BusUnbalance_Fault	Too much load on one leg (L1 or L2) vs. the other leg or DC loads on the AC output when Off-Grid. Grounded PV+/- wire can cause F20, F23, or F26.
F29	Parallel_CANBus_Fault	Usually, a communication error for parallel systems. Check cables, and MODBUS addresses.
F31	Soft_Start_Failed	Soft Start of the large motor failed.
F34	AC_Overload_Fault	AC Overload or load shorted. Reduce heavy loads.
F35	AC_NoUtility_Fault	Grid connection lost.
F37	DCLLC_Soft_Over_Cur	Software DC overcurrent.
F39	DCLLC_Over_Current	Hardware DC overcurrent.
F40	Batt_Over_Current	Batteries exceeded their current discharge limit.
F41	Parallel_System_Stop_Fault	If one system faults in parallel, this normal fault will register on the other units as they disconnect from the grid.
F45	AC_UV_OverVolt_Fault	Grid under voltage causes a disconnect. This will self-reset when the grid stabilizes.
F46	Battery_Backup_Fault	Cannot communicate with other parallel systems. Check Master = 1, Slaves = 2-9 and that ethernet are connected.
F47	AC_OverFreq_Fault	Grid over Frequency (common in power outages) causes disconnect. Will self-reset when grid stabilizes.
F48	AC_UnderFreq_Fault	Grid under Frequency (common in power outages) causes a disconnect. Will self-reset when grid stabilizes.
F55	DC_VoltHigh_Fault	PV may be higher than 500V. Battery voltage should not be above 59V or 63V (depending on the model).
F56	DC_VoltLow_Fault	Batteries are overly discharged, the inverter is Off-Grid and exceeded the programmed batt discharge current by 20%, or Lithium BMS has shut down. If battery settings are incorrect, this can also happen.
F58	BMS_Communication Fault	Sol-Ark is programmed to BMS Lithium Battery Mode but cannot communicate with a BMS. BMS_Err_Stop is enabled, but cannot communicate with a battery BMS
F60	Gen_Volt_or_Fre_Fault	Generator Voltage or Frequency went outside the allowable range.
F61	Button_Manual_OFF	The parallel Slave system turned off without turning off the Master.
F63	Arc_Fault	It can be a poor PV connector / Connection. Or sometimes a false alarm due to powerful lightning storms.
F64	Heatsink_HighTemp_Fault	Check that the built-in fans are running; the ambient temperature may be too high. Ensure proper clearance.

9. Warranty Verification Checklist

MUST complete this form **AFTER** the system is operational. To register the product warranty, this verification checklist must be filled out and submitted to Sol-Ark. Visit <https://www.sol-ark.com/register-your-sol-ark/> to register warranty.

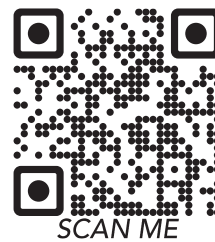

Installer/Company: _____ Date: (YYYY-MM-DD) _____

Inverter SN: _____ Gateway SN: _____

Mark ✓ for all that apply

Indicate the type of system (all that apply):

Grid-Tied only | Grid-Tied with battery backup | Off-Grid | Parallel system: # _____ inverters

Indicate integrated components (all that apply):

<input type="checkbox"/> Utility grid	<input type="checkbox"/> DC solar panels	<input type="checkbox"/> AC coupled solar panels	<input type="checkbox"/> Generator
<input type="checkbox"/> "LOAD" installed service panel	<input type="checkbox"/> "GRID" installed service panel	<input type="checkbox"/> "GEN" installed service panel	<input type="checkbox"/> Lithium batteries
<input type="checkbox"/> Lead-Acid batteries	<input type="checkbox"/> Wind Turbine		

⚠ It is strongly recommended to send a **Wiring Diagram** of the installation to support@sol-ark.com for verification, otherwise Sol-Ark expressly disclaims any responsibility for performance issues arising from improper installation. Installers and users are solely responsible for following proper installation procedures outlined in provided documentation. Sol-Ark disclaims any liability for changes in the installation that might result in electrical malfunctions or any other issues related to the Sol-Ark product.

! Circle **N/A (Not Applicable)** if the verification step is not relevant to the type of system or does not apply to the integrated components.

1. A wiring diagram of the installation was sent to Sol-Ark for verification	<input type="checkbox"/> Y <input type="checkbox"/> N
2. Setup for remote system monitoring through Wi-Fi / Ethernet is completed. Gateway SN: _____	<input type="checkbox"/> Y <input type="checkbox"/> N
3. The inverter is installed in a location where the LCD screen is always protected from direct sunlight	<input type="checkbox"/>
4. The inverter has the minimum specified vertical and lateral clearance for proper heat dissipation	<input type="checkbox"/>
5. The maximum DC input voltage does not surpass 500V _{DC}	<input type="checkbox"/>
6. The battery bank does not surpass 63V _{DC}	<input type="checkbox"/>
7. All battery conductors are properly connected and secured to the (+, -) terminals of the inverter	<input type="checkbox"/> N/A
8. Battery communication was successfully established	<input type="checkbox"/> N/A
9. All Battery Setup parameters are programmed according to battery manufacturer specifications	<input type="checkbox"/> N/A
10. The Sol-Ark properly generates power from the solar panels to charge the batteries	<input type="checkbox"/> N/A
11. Grid / Generator is properly connected to the Sol-Ark and the phase sequence was verified	<input type="checkbox"/> N/A
12. <input checked="" type="checkbox"/> "Grid / Gen Charge" settings are programmed correctly. Grid / Generator adequately charge the batteries	<input type="checkbox"/> N/A
13. For Off-Grid systems: The mode "General Standard" is programmed and the V & f ranges are increased	<input type="checkbox"/> N/A
14. When <input checked="" type="checkbox"/> "Grid Sell" is enabled, the Sol-Ark sells power back to the grid (negative HM measurements for L1, L2)	<input type="checkbox"/> N/A
15. Limit sensors are correctly installed on Grid lines / Generator lines	<input type="checkbox"/> N/A
16. Only when <input checked="" type="checkbox"/> "Limited Power to Home" is enabled, the Sol-Ark matches total load demand (Meter Zero)	<input type="checkbox"/> N/A
17. Disconnect the grid: during Off-Grid operation, the inverter properly supplies "LOAD" demand for PV and batteries	<input type="checkbox"/> N/A
18. Disconnect the grid AND solar panels: during Off-Grid operation, the inverter properly draws power from batteries	<input type="checkbox"/> N/A

In the event of system-related issues, forward a comprehensive description of the problem via email to support@sol-ark.com. Ensure the addition of images, including the "Details Screen" with all electrical measurements, as well as images of the inverter, wiring configuration, user area, batteries, and any other integral components constituting the power system.

Installer name and signature

Customer name and signature

Date

Limited Warranty: Sol-Ark 15K-2P-N

10-Year Limited Warranty for **Sol-Ark LLC** Products. Sol-Ark LLC provides a Ten-year (10) limited Warranty ("Warranty") against defects in materials and workmanship for its Sol-Ark LLC products ("Product"). The term of this warranty begins on the Product(s) initial purchase date, or the date of receipt of the Product(s) by the end user, whichever is later. This must be indicated on the invoice, bill of sale from your installer. This warranty applies to the original Sol-Ark LLC Product purchaser and is transferable only if the Product remains installed in the original use location. Please call Sol-Ark LLC to let us know if you are selling your Home and give us name and contact of the new owner.

Contact: (USA) +1-972-575-8875

For Info/Purchasing:

sales@sol-ark.com | ext.1

For Tech Support/Warranty Claim:

support@sol-ark.com | ext.2

The warranty does not apply to any Product or Product part that has been modified or damaged by the following:

- Installation or Removal (examples: wrong voltage batteries, connecting batteries backward, damage due to water/rain to electronics, preventable damage to solar wires.)
- Alteration or Disassembly.
- Normal Wear and Tear.
- Accident or Abuse.
- Unauthorized Firmware updates/software updates or alterations to the software code.
- Corrosion.
- Lightning: unless using EMP hardened system, then Sol-Ark LLC will repair the product.
- Repair or service provided by an unauthorized repair facility.
- Operation or installation contrary to manufacturer product instructions.
- Fire, Floods, or Acts of Nature.
- Shipping or Transportation.
- Incidental or consequential damage caused by other components of the power system.
- Any product whose serial number has been altered, defaced, or removed.
- Any other event not foreseeable by Sol-Ark LLC

Sol-Ark LLC liability for any defective Product, or any Product part, shall be limited to the repair or replacement of the Product, at Sol-Ark LLC discretion. Sol-Ark LLC does not warrant or guarantee workmanship performed by any person or firm installing its Products. This warranty does not cover the costs of installation, removal, shipping (except as described below), or reinstallation of Products or parts of Products. LCD screen and fans are covered for 5 years from date of purchase.

THIS LIMITED WARRANTY IS THE EXCLUSIVE WARRANTY APPLICABLE TO SOL-ARK LLC PRODUCTS. SOL-ARK LLC EXPRESSLY DISCLAIMS ANY OTHER EXPRESS OR IMPLIED WARRANTIES OF ITS PRODUCTS. SOL-ARK LLC ALSO EXPRESSLY LIMITS ITS LIABILITY IN THE EVENT OF A PRODUCT DEFECT TO REPAIR OR REPLACEMENT IN ACCORDANCE WITH THE TERMS OF THIS LIMITED WARRANTY AND EXCLUDES ALL LIABILITY FOR INCIDENTAL OR CONSEQUENTIAL DAMAGES, INCLUDING WITHOUT LIMITATION ANY LIABILITY FOR PRODUCTS NOT BEING AVAILABLE FOR USE OR LOST REVENUES OR PROFITS, EVEN IF IT IS MADE AWARE OF SUCH POTENTIAL DAMAGES.

Return Policy - No returns will be accepted without prior authorization and must include the Return Material Authorization (RMA) number. Please call and talk to one of our engineers to obtain this number at 972-575-8875.

Return Material Authorization (RMA) A request for an RMA number requires all the following information: 1. Product model and serial number; 2. Proof-of-purchase in the form of a copy of the original Product purchase invoice or receipt confirming the Product model number and serial number; 3. Description of the problem; 4. Validation of problem by Technical Support, and 5. Shipping address for the repaired or replacement equipment. Upon receiving this information, the Sol-Ark LLC representative can issue an RMA number. Any product that is returned must be brand new, in excellent condition and packaged in the original manufacturer's carton with all corresponding hardware and documentation. Returns must be shipped with prepaid freight and insured via the carrier of your choice to arrive back at Sol-Ark LLC within 30 days of your initial delivery or pick-up. **Shipping charges will not be refunded.** All returns are subject to a 35% restocking fee. **No returns will be accepted beyond 30 days of original delivery.** The value and cost of replacing any items missing (parts, manuals, etc.) will be deducted from the refund. If you have any questions regarding our return policy, please email us at sales@sol-ark.com or call us at the number above during regular (Monday to Friday) business hours.

Sol-Ark 15K-2P-N Install Operational Verification Checklist Questionnaire must be filled out, signed, and dated to secure full warranty coverage.

10. GUI Screens

1. Main Menu

Solar Today=0.0 KWH Total=0.0 KWH

System Alarms 1/25/2021 03:05:27 PM Mon.

Alarms Code	Occurred
F13 Grid_Mode_changed	2021-01-13 11:22
F13 Grid_Mode_changed	2021-01-13 11:20

Solar	Grid	INV	USP LD	Batt
0W	0W 0.0Hz	0W 0.0Hz	0W 0V	0W 0V
M1: 0V 0.0A 0W	0V HM: 0W LD: 0W	0V 0.0A 0W	0V 0V 0W	0V 0.0A 0.0C
M2: 0V 0.0A 0W	0V	0V	Gen	TEMP
M3: 0V 0.0A 0W	HM: 0W LD: 0W	0.0A 0W	0V 0.0Hz 0W	DC: 0.0C AC: 0.0C

0.00 V 0.00 A 0.0 C 0% 0 Ah
0.0 V 0.0 V 0A 0A 0x00 0x00

Only w/ BMS Lithium Mode

1. 0.00 V 0.00 A 0.0 C 0.0%	0.0V 0.0A 0j0j
2. 0.00 V 0.00 A 0.0 C 0.0%	0.0V 0.0A 0j0j
3. 0.00 V 0.00 A 0.0 C 0.0%	0.0V 0.0A 0j0j
4. 0.00 V 0.00 A 0.0 C 0.0%	0.0V 0.0A 0j0j
5. 0.00 V 0.00 A 0.0 C 0.0%	0.0V 0.0A 0j0j
6. 0.00 V 0.00 A 0.0 C 0.0%	0.0V 0.0A 0j0j
7. 0.00 V 0.00 A 0.0 C 0.0%	0.0V 0.0A 0j0j
8. 0.00 V 0.00 A 0.0 C 0.0%	0.0V 0.0A 0j0j
9. 0.00 V 0.00 A 0.0 C 0.0%	0.0V 0.0A 0j0j
10. 0.00 V 0.00 A 0.0 C 0.0%	0.0V 0.0A 0j0j
11. 0.00 V 0.00 A 0.0 C 0.0%	0.0V 0.0A 0j0j
12. 0.00 V 0.00 A 0.0 C 0.0%	0.0V 0.0A 0j0j
13. 0.00 V 0.00 A 0.0 C 0.0%	0.0V 0.0A 0j0j

System Setup 10/14/2022 03:05:27 PM Fri.

Basic Setup

Battery Setup

Limiters Grid Setup

System Alarms

Only w/ BMS Lithium Mode

Li-Batt Info

Sol-Ark 5K/8K/12K/15K-P
- ID: #####
- COMM: ####
- MCU: Ver####

2. Basic Setup

Basic Setup

Display Time Advanced Factory Reset Parallel

Brightness Beep

Auto Dim 600S

CANCEL OK

Basic Setup

Display Time Advanced Factory Reset Parallel

AM/PM Year: 2021 Month: 10 Day: 26

Time Sync PM Hour: 03 Minute: 04 Second: 15

Seasons Start M-D: 1 - 1 Season 2: 4 - 1 Season 3: 8 - 1

End M-D: 4 - 1 8 - 1 12 - 1

CANCEL OK

Basic Setup

Display Time Advanced Factory Reset Parallel

Solar Arc Fault ON Clear Arc_Fault

Gen Limit Power: 15000W

Load Limit Power: 15000W

Grid peak-shaving Power: 15000W

Auto detect Home Limit Sensors CT ratio: 2000

UPS Time: 0ms

ARC parameters: 030000, 045000, 000400, 000050, 000390, 000055, 238094

CANCEL OK

Basic Setup

Display Time Advanced Factory Reset Parallel

Factory Reset System selfcheck

Lock out all changes Test Mode

Lock Grid Charging & Limited

CANCEL OK

Basic Setup

Display Time Advanced Factory Reset Parallel

Parallel Master Modbus SN: 00 Phase A

Slave Phase B

Phase C

Meter > Grid Meter > Load

Meter Select: No Meter

CANCEL OK

3. Batt Setup

Batt Setup

Batt Capacity: 400Ah Use Batt V Charged
 Max A Charge: 275A Use Batt % Charged
 Max A Discharge: 275A No Battery
 TEMPCO: -0mV/C/Cell BMS Lithium Batt 00
 Activate Battery

CANCEL OK

Batt Setup

StartV: 49.0V 49.0V Float V: 55.7V
 Start%: 30% 50% Absorbtion V: 56.0V
 A: 40A 100A Equalization V: 56.0V
 Gen Charge Grid Charge
 30 Days 1.0 Hours
 Generator Exercise Cycle Day & Time>> Mon 08 :00 20min
 Gen Force

CANCEL OK

Batt Setup

Shutdown: 46.0V 20% Batt Resistance: 8mOhms
 Low Batt: 47.5V 35% Batt Charge Efficiency: 99.0%
 Restart: 52.0V 50%
 Batt Empty V: 47.0V BMS_Err_Stop

CANCEL OK

Batt Setup

Use gen input as load output For AC Coupled Input to Gen
 On Grid always on High Frz: 62.00Hz
 Smart Load OFF Batt: 51.0V 80% AC couple on load side
 Smart Load ON Batt: 54.0V 90%
 Solar Power(W): 500W

CANCEL OK

4. Limiter

Grid Param

Grid Sell: 15000
 Limited Power to Home: 05:00AM 2000 50%
 Limited Power to Load: 09:00AM 2000 100%
 Time of Use Setup: 01:00PM 2000 100%
 05:00PM 2000 50%
 09:00PM 2000 50%

CANCEL OK

Grid Param

Time of Use Setup

Mon. Tues. Wed. Thur.
 Fri. Sat. Sun.
 Season1 Season2 Season3

CANCEL OK

Grid Param

GEN connect to Grid Input
 Zero Export Power: 10W
 Batt First Load First

CANCEL OK

5. Grid Setup

Grid Param

Grid Selection: Connect IP F(W) V(W)/V(Q) P(Q)/P(F)
 Grid Mode: 3/3 Grid Reconnect Time: 300s
 UL17415B Power Factor: 1.000
 Grid Frequency: 50Hz 60Hz Fixed Q: 0%
 Single Phase Q_Response: 10s
 120/240V Split Phase Output V: 120/208V
 120/208V 3 Phase Output V+: +0V

CANCEL OK

Grid Param

Grid Selection: Connect IP F(W) V(W)/V(Q) P(Q)/P(F)
 Reconnect: Grid Vol High: 228.6V Grid Vol Low: 183.2V
 Grid Hz High: 61.5Hz Grid Hz Low: 58.5Hz
 Reconnect Ramp rate: 60s
 Normal connect: Grid Vol High: 249.6V Grid Vol Low: 104.0V
 Grid Hz High: 62.0Hz Grid Hz Low: 57.0Hz
 Normal Ramp rate: 60s

CANCEL OK

Grid Param

Grid selection: Connect IP F(W) V(W)/V(Q) P(Q)/P(F)
 Over Voltage U> (10 min. running mean): 239.2V
 HV3: 249.6V HF3: 62.00Hz
 HV2: 249.6V -- 0.16s HF2: 62.00Hz -- 0.16s
 HV1: 249.6V -- 13.00s HF1: 61.50Hz -- 299.00s
 LV1: 183.0V -- 21.00s LF1: 58.50Hz -- 299.00s
 LV2: 145.6V -- 2.00s LF2: 57.00Hz -- 0.16s
 LV3: 104.0V LF3: 57.00Hz

CANCEL OK

Grid Param

Grid selection: Connect IP F(W) V(W)/V(Q) P(Q)/P(F)
 Over frequency: Droop F: 40%PE/Hz F(W)
 Start freq F: 60.50Hz Stop freq F: 60.50Hz
 Start delay: 0.00s Stop delay: 0.00s
 Under frequency: Droop F>: 40%PE/Hz
 Start freq F>: 59.50Hz Stop freq F>: 59.50Hz
 Start delay F>: 0.00s Stop delay F>: 0.00s

CANCEL OK

Grid Param

Grid selection: Connect IP F(W) V(W)/V(Q) P(Q)/P(F)
 V(W) V(Q)
 Response_T: P1:100% Lin:20.0% Lout:5.0%
 V1:109.0% P1:100% V1:90.0% Q1:43%
 V2:110.0% P2:50% V2:94.0% Q2:0%
 V3:111.0% P3:0% V3:106.0% Q3:0%
 V4:112.0% P4:0% V4:110.0% Q4:-43%

CANCEL OK

Grid Param

Grid selection: Connect IP F(W) V(W)/V(Q) P(Q)/P(F)
 P(Q) P(F)
 P1:20% Q1:20% Lin:50.0% Lout:100.0%
 P2:100% Q2:20% V1:50% F1:1.000
 P3:100% Q3:20% V2:100% F2:0.800
 P4:100% Q4:20% V3:100% F3:0.800
 V4:100% F4:0.800

CANCEL OK

